

Valuetronics International, Inc.
1-800-552-8258
MASTER COPY

Precision Magnetics Analyzer

PMA3260A

User Manual

WAYNE KERR ELECTRONICS LIMITED



An Advance International company



PRECISION
MAGNETICS ANALYZER
PMA3260A
User Manual
Part N° 9HPMA3260A

Wayne Kerr Electronics Ltd
Durban Road, Bognor Regis, West Sussex, England PO22 9RL
Tel 01243 825811 • Fax 01243 824698
Ver 3.1 • 08 September 1997

© Wayne Kerr Electronics Ltd 1995, 1996, 1997

The copyright in this work is vested in Wayne Kerr Electronics Ltd and this document is issued for the purpose only for which it is supplied. No licence is implied for the use of any patented feature. It must not be reproduced in whole or in part, or used for tendering or manufacturing purposes except under an agreement or with the consent in writing of and then only on the condition that this notice is included in any such reproduction. Information furnished is believed to be accurate but no liability in respect of any use of it is accepted by Wayne Kerr Electronics Ltd.

Contents

1. SAFETY	6
1.1 GENERAL	6
1.2 AC POWER SUPPLY	6
1.3 ADJUSTMENT, MAINTENANCE AND REPAIR	7
1.4 STATIC ELECTRICITY	7
2. SCHEDULE OF EQUIPMENT	8
3. INTRODUCTION	9
3.1 DESCRIPTION	9
3.1.1 PMA3260A	9
3.1.2 PMA3260P	9
3.2 GUARANTEE	10
3.3 STORAGE & SHIPMENT	10
4. SPECIFICATION	11
4.1 MEASUREMENT PARAMETERS	11
4.1.1 Impedance Mode	11
4.1.2 Handler Mode.....	11
4.1.3 Transformer Mode.....	11
4.2 TEST CONDITIONS	11
4.2.1 Low level AC drive	11
4.2.2 Frequency range.....	11
4.2.3 Steps (basic model).....	11
4.2.4 Steps (HF option)	11
4.2.5 Drive level (Source impedance 50 Ω)	12
4.2.6 DC bias current (Impedance modes only).....	12
4.2.7 DC resistance	12
4.2.8 Insulation (option).....	12
4.3 MEASUREMENT SPEEDS.....	12
4.4 MEASUREMENT RANGE	12
4.5 BASIC ACCURACY	12
4.5 GENERAL DATA.....	13
4.5.1 Input Specification.....	13
4.5.2 Display.....	13
4.5.3 Measurement connections	13
4.5.4 Remote control.....	13
4.5.5 Environmental conditions.....	13
4.5.6 Safety	14
4.5.7 EMC.....	14
4.5.8 Mechanical	14
4.5.9 Accessories supplied.....	14
4.5.10 Options	14
4.5.11 Panel Symbols Used	14
5. INSTALLATION	15
5.1 AC LINE CONNECTIONS	15
5.2 SAFETY INTERLOCK.....	15

5.3 RACK MOUNTINGS	16
5.4 MEASUREMENT CONNECTIONS	16
6. OPERATING INSTRUCTIONS AND APPLICATIONS.....	17
6.1 FIRST-TIME OPERATION	17
6.1.1 Basic Information PMA3260A Only	17
6.1.2 Menu structure PMA3260A Only.....	18
6.1.3 Basic features.....	18
6.1.4 Connections.....	20
6.1.5 Trimming.....	20
6.1.6 Set up measurement.....	21
6.1.7 Impedance mode.....	21
6.1.8 Transformer mode.....	22
6.2 ADVANCED USAGE.....	23
6.2.1 Basic theory.....	23
6.2.2 Front Panel Connections	24
6.2.3 Manual range selection.....	25
6.2.4 Automatic Level Control(ALC)	25
6.2.5 Measuring Small value inductors.....	26
6.2.6 Measuring Air-cored inductors	26
6.2.7 Iron-cored inductors	26
6.2.8 Internal DC bias.....	28
6.2.9 Transformer mode.....	29
6.2.10 Handler mode.....	30
6.2.11 Self-capacitance and resonance.....	30
6.2.12 Data entry keyboard PMA3260A Only	31
6.2.13 Global and non-global measurement conditions	33
6.2.14 Percentage and absolute limit display PMA3260A Only.....	34
6.2.15 Sequence edit mode PMA3260A	35
6.2.16 Sequence run mode	38
6.2.17 Calibration.....	40
6.3 OPTIONAL MODULES.....	41
6.3.1 Insulation Test.....	41
6.3.2 Extended Frequency Option.....	42
6.3.3 Bin Handler Option.....	43
6.4 KEYPAD FUNCTIONS	50
6.4.1 CODE FUNCTIONS.....	50
6.4.2 RESET.....	51
6.5 REFERENCE TABLES	52
6.5.1 Default instrument state	52
6.6 GPIB CONTROL	53
6.6.1 Introduction.....	53
6.6.2 Interface Specification.....	53
6.6.3 Changing GPIB Address.....	54
6.6.4 Communication Syntax.....	54
6.6.5 Data Output.....	56
6.6.6 Status Reporting	57
6.6.7 Common Commands	62
6.6.8 Standard Operation Status Commands.....	62
6.6.9 PMA3260A Device-Specific Commands	63
6.6.10 Programming Examples.....	71

6.7 VIRTUAL FRONT PANEL SOFTWARE	74
6.7.1 Introduction	74
6.7.2 Hardware Requirements	75
6.7.3 Software Requirements	75
6.7.4 Installation	75
6.7.5 Using the Virtual Front Panel Software	76
6.8 PRINTER OPERATION	80
6.8.1 Print Functions	81
6.9 BACK PANEL	84
6.9.1 SAFETY Interlock	85
6.9.2 GPIB	86
6.9.3 Trigger IN	87
6.9.4 Auxiliary IN	87
6.9.5 Auxiliary Control OUT	87
6.9.6 Auxiliary AC OUT	87
6.9.7 Parallel Printer	87
6.9.8 Bin Handler Interface	88
6.9.9 Set GPIB Address (PMA3260P Only)	88
7. CLEANING AND SAFETY INSPECTION	89
7.1 CLEANING	89
7.2 SAFETY INSPECTION	89

1. SAFETY

1.1 General



This equipment has been designed to meet the requirements of EN61010-1 “Safety requirements for electrical equipment for measurement, control and laboratory use” and has left the factory in a safe condition.

This equipment is intended for use by suitably trained and competent persons.

This equipment can cause hazards if not used in accordance with these instructions. Read them carefully and follow them in all respects.

Do not use this equipment if damaged.

WARNING! Lethal back emf potentials can be generated if an inductor under test is disconnected whilst current is still flowing in it. Appropriate precautions must be taken (see section 6.9.1 - Safety Interlocks).

1.2 AC Power Supply

Power cable and connector requirements vary between countries. Always use a cable that conforms to local regulations, terminated in an IEC320 connector at the instrument end.

If it is necessary to fit a suitable AC. power plug to the power cable, the user must observe the following colour codes:

WIRE	EUROPEAN	N. AMERICAN
LIVE	BROWN	BLACK
NEUTRAL	BLUE	WHITE
EARTH	GREEN/YELLOW	GREEN

The user must also ensure that the protective earth lead would be the last to break should the cable be subject to excessive strain.

If the plug is fused, a 3-amp fuse should be fitted.

If the power cable electrical connection to the AC. power plug is through screw terminals then, to ensure reliable connections, any solder tinning of the cable wires must be removed before fitting the plug.

WARNING! Any interruption of the protective earth conductor inside or outside the equipment or disconnection of the protective earth terminal is likely to make the equipment dangerous. Intentional interruption is prohibited.

Before switching on the equipment, ensure that it is set to the voltage of the local AC. power supply.

1.3 Adjustment, Maintenance and Repair

When the equipment is connected to the local AC. power supply internal terminals may be live and the opening of the covers or removal of parts (except those to which access can be gained by hand) is likely to expose live parts. The equipment must be disconnected from all voltage sources before it is opened for any adjustments, replacement maintenance or repair.

Capacitors inside the equipment may still be charged even if the equipment has been disconnected from all voltage sources.

Any adjustment, maintenance and repair of the opened equipment under voltage must be carried out by a skilled person who is aware of the hazards involved.

Ensure that only fuses with the required rated current and of the specified type are used for replacement. The use of makeshift fuses and short circuiting of fuse holders is prohibited.

1.4 Static Electricity

The unit supplied may use static sensitive devices and service personnel should be alerted to components which require handling precautions to avoid damage by static electrical discharge.

Before handling circuit board assemblies containing these components, personnel should observe the following precautions:

1. The work surface should be a conductive grounded mat.
2. Soldering irons must be grounded and tools must be in contact with a conductive surface to ground when not in use.
3. Any person handling static sensitive parts must wear a wrist strap which provides a leaky path to ground, impedance not greater than 1 MΩ.
4. Components or circuit board assemblies must be stored in or on conductive foam or mat while work is in progress.

New components should be kept in the suppliers packaging until required for use.

2. SCHEDULE OF EQUIPMENT

The instrument has been carefully packed to prevent damage in transit. When removing the unit from the packing box, ensure that all parts and accessories are removed from the packing material. Retain the packing box and material.

The complete equipment comprises:

**Wayne Kerr
Part Number**

1 off PMA3260A PRECISION MAGNETICS ANALYZER	1EVPMA3260A
OR	
1 off PMA3260P INDUCTANCE ANALYZER	1EVPMA3260P
1 off detachable AC power lead	HC22V2
1 off User Manual	9HPMA3260A
1 off spare fuse (1A-T Amp (230V AC))	FT1A00123
1 off spare fuse (2A-T Amps (115V AC))	FT2A00123
1 off Bias Safety Interlock	TG223
1 off Transfer Standard Kit (High Frequency Option Only)	4N3269TS

Options that are fitted will have been installed in the factory. The presence of these options can be checked accessing the 'INSTRUMENT STATUS' screen via the 'MAIN MENU'. See section 6.1.2 for details.

NOTE: In the event of damage in transit or shortage in delivery separate notices in writing should be given to both carriers and WAYNE KERR Electronics Limited, or local agent if outside the UK, within three days of receipt of goods, followed by a complete claim within five days. All goods which are the subject of any claim for damage in transit or missing items should be preserved intact as delivered, for a period of seven days after making the claim, pending inspection or instructions from WAYNE KERR Electronics Limited, or any agent of this company.

3. INTRODUCTION

3.1 Description

3.1.1 PMA3260A

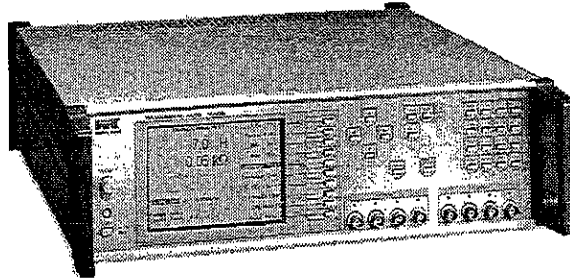

figure 3.1 PMA3260A Precision Magnetics Analyzer

The PMA3260A is a versatile instrument which can be used on the bench top or rack mounted.

All test functions are available from the front panel making the analyzer very easy to use.

Semi-automatic testing and IEEE 488.2 are supported.

3.1.2 PMA3260P

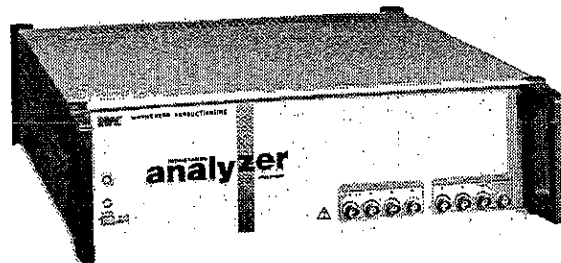

figure 3.2 PMA3260P Precision Magnetics Analyzer

The PMA3260P Production Line Analyzer has all the facilities of the PMA3260A controlled by the GPIB Interface.

The instrument is intended to be used with an IEEE 488.2 compatible controller.

3.2 Guarantee

The equipment supplied by WAYNE KERR Electronics Limited is guaranteed against defective material and faulty manufacture for a period of twelve months from the date of dispatch. In the case of material or components employed in the equipment but not manufactured by us we allow the customer the period of any guarantee to us.

The equipment has been carefully inspected and submitted to comprehensive test at the factory prior to dispatch. If, within the guarantee period, any defect is discovered in the equipment in respect of material or workmanship and reasonably within our control, we undertake to make good the defect at our own expense subject to our standard conditions of sale. In exceptional circumstances and at the discretion of the Service Manager, a charge for labour and carriage costs incurred may be made.

Our responsibility is in all cases limited to the cost of making good the defect in the equipment itself. The guarantee does not extend to third parties, nor does it apply to defects caused by abnormal conditions of working, accident, misuse, neglect or wear and tear.

3.3 Storage & Shipment

The instrument should be stored in a clean dry environment. The following environmental limitations apply to both storage and shipment:

Temperature	-40°C to +70°C (-40°F to +158°F)
Relative Humidity	95% to +40°C non-condensing.

When returning the instrument please ensure adequate care is taken with packing and arrange insurance cover against transit damage or loss. If possible re-use the original packing box, following the instructions below:

Wrap the instrument, together with accessories and instruction/service manual, in anti-static polystyrene and seal with adhesive tape. Fit the original polystyrene packing pieces to the sides of the unit and place in original packing box. Seal the box with heavy duty adhesive tape.

4. SPECIFICATION

4.1 Measurement Parameters

Any of the following parameters can be measured and displayed:

4.1.1 Impedance Mode

Inductance (L), Impedance (Z), Rdc and Capacitance.

Loss term: Quality factor (Q), Dissipation factor (D), Rac and angle.

Analogue scale (bargraph) with nominal, absolute and % modes.

4.1.2 Handler Mode

Enables existing 4-wire scanners to be used .

Functions as impedance mode with the addition of turns ratio.

Analogue scale not available

4.1.3 Transformer Mode

Rdc of each winding, Primary or Secondary Leakage Inductance and Q, Turns Ratio, Interwinding Capacitance and Leakage Inductance. Insulation between windings or from either winding to screen/core is available as an option.

4.2 Test Conditions

4.2.1 Low level AC drive

For measurement of L + Q, Ls + Rs, C, Z, Turns ratio and Leakage Inductance.

4.2.2 Frequency range

20Hz to 500kHz (basic model).

20Hz to 3MHz (option).

Interwinding C minimum frequency 1kHz.

4.2.3 Steps (basic model)

Independent settings are available for different tests.

At least 1000 frequencies, which may be selected via keyboard or GPIB.

Basic accuracy of selected frequency $\pm 0.01\%$.

4.2.4 Steps (HF option)

Frequency extended to 3MHz.

Increments of 1% or better across range 1200 frequencies approx.

Accuracy of selected frequency $\pm 0.01\%$

4.2.5 Drive level (Source impedance 50Ω)

1mV to 10V rms into open circuit

50μ to 200mA rms into short circuit

ALC ensures level at DUT is ±2%, ±1mV of set voltage or ±2% ±0.1mA of set current

4.2.6 DC bias current (Impedance modes only)

1mA to 1A dc is available from internal, fast settling bias supply over full frequency range.

Voltage compliance 20V minimum.

Safety Interlock.

4.2.7 DC resistance

Low test level 100mV

Short circuit current 10mA

4.2.8 Insulation (option)

Test voltages of 100, 200 or 500V dc. User selectable Voltage accuracy ±3%.

For user safety, short circuit current is limited to <2mA.

4.3 Measurement Speeds

For impedance, turns ratio, dc resistance and insulation 4 speeds selectable for all functions: Maximum, fast, medium and slow. Maximum for remote control.

Up to 20 measurements per second for test frequency ≥100Hz. Selecting slower speeds improves accuracy and display resolution.

4.4 Measurement Range

R	0.01mΩ - > 2GΩ *
L	0.1nH - > 1000H *
C	5fF - > 1F *

4.5 Basic Accuracy

Inductance/Rac/Z/Cp	±0.1% **
Q	±0.1 (Q+1/Q)% **
D	±0.001 (1 + D2) **
Turns ratio	±0.1% **
Rdc	±0.5%
Insulation	±5% (500V test)

* Varies with measurement speed ** Varies with frequency and option chosen.

4.5 General Data

4.5.1 Input Specification

Input Voltage	115V AC $\pm 10\%$ or 230V AC $\pm 10\%$ (Selectable)
Frequency	50/60Hz
VA rating	150VA
Input fuse rating	115V operation - 2A "T" type 230V operation - 1A "T" type

The input fuse is the fuseholder drawer integral to the IEC input connector.

4.5.2 Display

High contrast black and white LCD module 320 x 240 dot with CFL back lighting. Visible area 115 x 86mm. Viewing angle 45°.

4.5.3 Measurement connections

8 off front panel BNC sockets.
2- or 4-wire (Kelvin) measurements with screen at ground potential.
Equivalent circuit symbols on screen.
Separate terminals for primary and secondary connections.
Indication of active sockets.

4.5.4 Remote control

Designed to GPIB (IEEE 488.2) and SCPI 1992.0.

4.5.5 Environmental conditions

Temperature Range

Storage	-40°C to +70°C
Operating	0°C to 40°C
Full Accuracy	15°C to 35°C

Altitude up to 2000m

Relative Humidity: up to 80% non conducting.

Installation category:II (in accordance with IEC664)

Pollution degree: 2 (mainly non-conductive)

This equipment is intended for indoor use only in non-explosive, non corrosive atmosphere.

4.5.6 Safety

Designed to meet the requirements of EN61010-1.

4.5.7 EMC

Complies with EN50081-1, EN50082-1 generic emissions and immunity standards by meeting with the requirements of EN55022, IEC801.2, EN801.3 & IEC 801.4.

4.5.8 Mechanical

Height 150mm (6")

Width 440mm (17 3/8")

Depth 520mm (20 1/2")

Weight 11kg (24 lb. 4 oz.)

4.5.9 Accessories supplied

AC power cable 2m.

User Manual.

4.5.10 Options

HF option (extends operating frequency to 3MHz).

Insulation testing.

A range of test leads and fixtures is available.

Rack mounting kit.

4.5.11 Panel Symbols Used



Refer to handbook.



Alternating current



Earth (ground) terminal



CAUTION - Risk of electric shock.



On



Off

5. INSTALLATION

5.1 AC Line Connections

This unit is provided with a mains lead capable of carrying the input current for both 115V and 230V operation. This lead should be connected via a suitable connector to the local mains supply. The colour code employed is as follows:

WIRE	N. AMERICAN	EUROPEAN
LIVE	BLACK	BROWN
NEUTRAL	WHITE	BLUE
EARTH	GREEN	GREEN/YELLOW

The supply voltage can be checked by looking through the transparent window on the rear panel next to the power inlet socket. This can be changed by first removing from the electrical supply, removing the window and adjusting the switch to read the required voltage. Replace the window and ensure that the fuse rating is correct:

230V	1A-T
115V	2A-T

No adjustment is required for variation of supply frequency.

Before connecting the ac power, read the precautions listed under section 1 SAFETY - AC POWER SUPPLY.

The instrument is not suitable for battery operation.

The power switch is located on the left of the front panel.

5.2 Safety Interlock

WARNING!

Improper use of this instrument could be fatal

To protect the user against lethal back emf potentials, there is a facility to inhibit the operation of a DC bias current function. This can be inhibited by removing the 'BIAS SAFETY INTERLOCK' plug on the rear panel. Details of this feature can be found in section 6.9.1. This safety interlock plug is supplied with the unit and in order to use the bias current feature, this plug must be inserted.

5.3 Rack Mountings

This instrument is intended for use either on the bench or in a rack. The power modules are convection cooled and care must be taken not to restrict any of these air paths.

There is a rack mounting kit available as an optional extra to fit a standard 19" rack. This kit contains the mounting "ears" and screws required for the conversion. To fit these "ears" carefully remove the insert in the outer face of both front handles. See figure 5.1 below. Fit each "ear" into the recess formed by the removal of the insert and secure using the bolts provided (M4 x 10mm CSK). It is important that some provision be made to support the rear of the unit when using the rack mounting ears.

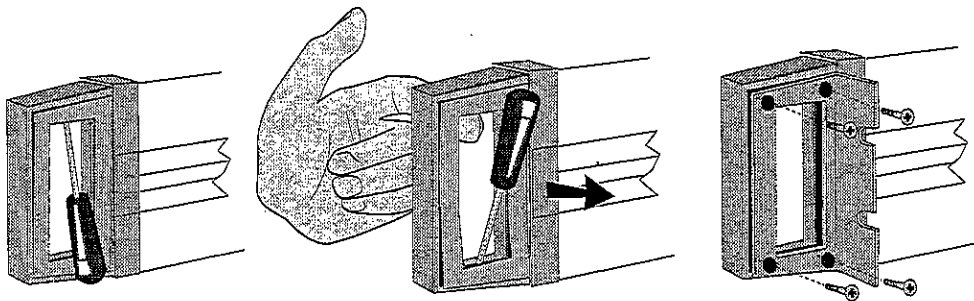

Insert small screwdriver into the gap between insert and handle body. Prise away one end slightly and hold in position with finger. Note operation of insert with styling cut-out opposite cut out in handle.

Insert screwdriver into other end and repeat procedure. This will relieve the small tapered pins of the insert from the threaded holes in the handle. Remove insert in the direction of arrow.

Insert rack mounting bracket into recess in handle in attitude shown and secure firmly with 4 M4x10 C'SK HD screws supplied.

figure 5.1 Procedure for Attachment of Rack mounting brackets

5.4 Measurement Connections

There are no measurement leads supplied with this unit. Any leads can be used provided they meet the requirements as laid out in section 6.2.2 'Front Panel Connections'

6. OPERATING INSTRUCTIONS AND APPLICATIONS

6.1 First-time Operation

The PMA3260P does not have a front panel display and keyboard and requires an IEEE 488.2 compatible controller for operation. See section 6.6 for details of the specific commands available. For new users of the PMA3260P it may be helpful to consult all parts of this section to while writing instrument control programs.

6.1.1 Basic Information PMA3260A Only

An introduction to the analyzer falls into the same four parts as the instrument front panel, that is: Display, Master controls, connections and Keypad (see Fig. 6.1).

The Display is a back-lit liquid crystal display(LCD). The main area shows results in numeric and graphic form, together with instructions, warnings, pop-up information messages, and information on parameters selected or needed. The right-hand side of the LCD defines the row of ten 'soft' keys whose functions depend on the operation mode in use.

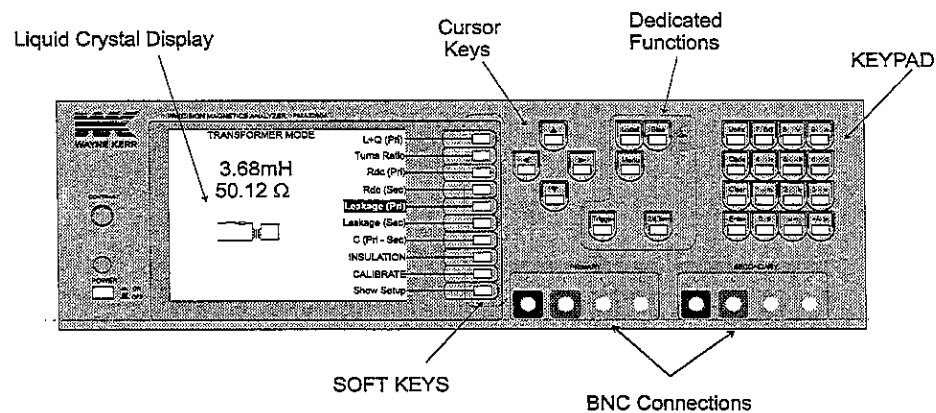

Figure 6.1 PMA3260A Front Panel

The Master Controls consist of the ten 'soft' keys, four cursor keys and five with dedicated functions. Pressing the 'Local' key restores control to the front panel when the GPIB mode is in use. The Bias key toggles the DC bias on/off state. The LED associated with this key shows the bias state. The 2/4 Term key selects two or four terminal measurements. The two horizontal cursor keys "←" and "→" move the highlighted cursor in the display to the left and right respectively. The two vertical cursor keys "↑" and "↓" change the values of the highlighted parameter in predetermined steps. The Trigger key initiates a single measurement. If it is pressed and held, the Analyzer will fall into repetitive measurement mode until the key is released. The fifth key in this group is Menu, which calls up a list of the various operating modes available. A summary of these modes is given in the section 6.1.2 'Menu structure'. Detailed information appears later in the Manual.

The instrument has separate screened Kelvin connections for primary and secondary windings. For simple 2-wire components, use the primary

connections. See section 6.1.4 for details of use, or section 6.2.2 for advanced usage.

The Keypad provides the means for input of numerical values, multipliers and units. Required values of a highlighted parameter may be input. Full details of its use appears in Section 6.2.12 'Data entry keyboard' and again in various later sections of this Manual.

6.1.2 Menu structure PMA3260A Only

The menu structure is designed to provide easy access to instrument functions. Soft keys are labeled on the main menu display to enable the required mode to be obtained by pressing the appropriate key. Pressing the Clear key restores the previous menu.

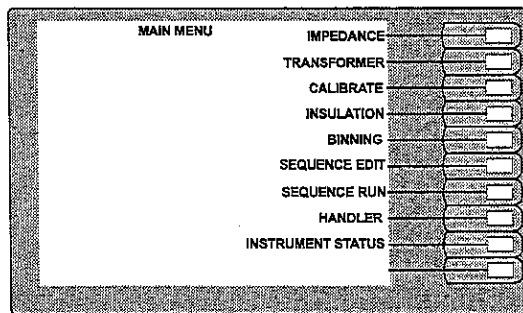

Figure 6.2 PMA3260A Main Menu Display

6.1.3 Basic features

'Impedance mode' is normally used for obtaining AC or DC measurements of component values, together with secondary characteristics such as D, Q and loss resistance. Any of these values may be compared in absolute or percentage terms with nominal values to give a pass/fail indication on screen. The display incorporates an analogue scale bar. Further information on 'Impedance mode' is in section 6.1.7.

'Transformer' mode is for measuring various parameters of transformers. There are seven types of transformer test depicted on seven 'soft' keys. A single key stroke will restore the preset test conditions of the corresponding test, configure the test connections and trigger a measurement. This greatly simplifies complex test procedures. The 'Insulation' mode can also be accessed from this mode if this option is fitted. Further information on the 'Transformer mode' is in section 6.1.8.

'Calibrate' is an operating mode which allows the operator to establish more than one set of open-circuit and short circuit corrections, corresponding to different input lead configurations. When the extended frequency option is fitted, high frequency lead compensations for connecting lead length can also be stored. Instrument self-calibration is required periodically. Further information on Calibration is in section 6.2.17. The various Trimming modes available here are explained in section 6.1.5 'Trimming'.

'Insulation' test is an optional operating mode. If the hardware module is fitted, this mode can be accessed to provide insulation tests between windings, and

from each winding to ground. This is a three-terminal DC test. Further information on the 'Insulation' test is in section 6.3.1.

'Binning Mode' is optional and provides the capability to drive an external bin handler and also provide a pass/fail output. A 25 way D connector (male) is provided at the rear of the instrument to connect to Bin handling equipment. The option enables the instrument to measure a component, sort it into one of the ten bins according to the measurement results and then provide the signals for external bin handling hardware to physically "bin" the component. Further information on 'Binning Mode' is in section 6.3.3 and 6.9.8.

'Sequence Edit' mode for transformers enables an operator to enter a sequence of tests to be performed on each winding in turn, with PASS/FAIL limits for each test. A sequence program can be loaded, viewed and edited in this mode. Up to 150 programs can be stored in the non-volatile memory of the instrument and can be uploaded or downloaded via GPIB. Further information on 'Sequence Edit' is in section 6.2.15 and 6.8.1.

'Sequence Run' mode provides semi-automatic testing (connections changed manually) or fully automated testing (connections changed by a scanner). A supervisor can load up a program and then lock keys electronically. An operator can then simply follow the instructions on the LCD to change connections and observe PASS/FAIL results. Further information on 'Sequence Run' is in section 6.2.16.

'Handler' mode reconfigures the front panel connections in such a way as to make this instrument compatible with many existing 4 terminal fixtures and scanners, in this case two of the primary and two of the secondary connections are used. Further information on the 'Handler' mode is in section 6.2.10.

'Instrument Status' mode provides readout and data entry for the software version and date, list of options installed, GPIB address, global or non-global measurement conditions, coarse or fine frequency steps. A real-time clock is built into the Analyzer. Time and date are displayed in this mode. Correct time and date can be set by a code function (see section 6.4.1).

The instrument at power-up is normally restored to the previous state, except that for the BIAS will be turned OFF. Also when SINGLE SHOT was operative, there will be no measurement result. If the previous 'set-up' has been lost - arising from corruption of non-volatile RAM - then a warning is displayed and the corrupted block will be replaced by its default values. When this happens the input leads will need to be re-calibrated and the new operating data keyed in. The default values are listed in section 6.5.1.

Pressing Menu displays the main menu of operating modes. Any may be selected by pressing the button adjacent to its displayed legend (see figure 6.2).

Alternative measurement speeds can be selected - MAXimum, FAST, MEDIUM or SLOW - by pressing the "↑" and "↓" cursor keys when 'SPEED' is highlighted. MAXimum speed makes approximately 25 measurements per second, which is normally used for fast component sorting under GPIB. FAST speed makes about 10 measurements per second. SLOW gives longer integration time, hence greater stability and accuracy.

6.1.4 Connections

The instrument features 8 BNC connections on the front panel. Four BNC sockets provide screened Kelvin connections for transformer primary or impedance measurements and four additional BNC sockets provide Kelvin connections for transformer secondaries. Kelvin clip leads of the type A40100(fine jaw) or A40180(heavy jaw) are suitable for all measurement modes.

The PMA3260P requires a GPIB controller to be connected for operation.

Descriptions of the rear panel connections for the instrument can be found in section 6.9.

6.1.5 Trimming

The purpose of trimming is to eliminate the effects of stray capacitance or series impedance in the connecting leads or fixture. This must be done each time that lead sets or component fixtures are changed, or whenever the instrument is switched between 4 terminal and 2 terminal operation.

The previously used trim values are held in non-volatile stores. They are applied automatically at all frequencies, levels and ranges. Therefore, for the majority of measurements, no re-trimming is necessary. The exceptions are when the test connections are changed, and when the highest possible accuracy is required for measurements of very high or very low impedance's.

For normal impedance measurements only Open Circuit trim (primary) and Short Circuit trim (primary) are required.

For S/C trim the connector jaws should be clipped to a piece of wire as close together as possible. Do not connect the clips directly together as this will lead to trim errors. To provide a true low impedance S/C at high frequencies (as with extended frequency option) this trim should be repeated with a piece of foil.

For O/C trim the Kelvin clips should be at least 5cm apart from each other.

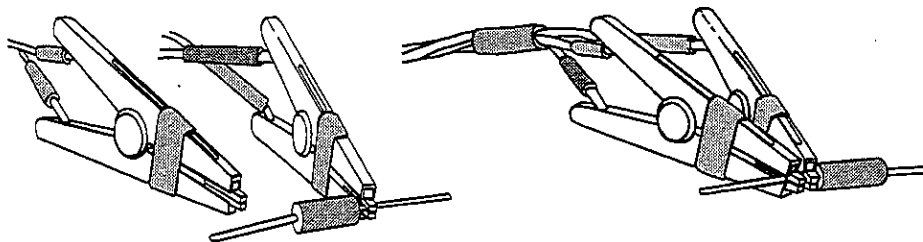

Figure 6.3 Connections for O/C and S/C trimming of KELVIN clips

During trimming, the analyzer makes measurements at a number of frequencies, storing the corrections for each. These measurements are made at levels of 1V and 2.5V on Trim O/C or 50mA on Trim S/C and at a number of frequencies within the selected band together with the measurement frequency in use when trim was initiated. Best measurement results are obtained under these conditions. If the measurement frequency is subsequently altered, the Analyzer automatically applies a new correction value derived from the stored values by interpolation.

The PMA3260P is trimmed by using the GPIB commands in place of the front panel keyboard entries. See section 6.6.7 for details.

The trimming procedure is as follows:

Ensure that 2 terminal or 4 terminal operation is selected as required. See section 6.2.2

1. Select Calibrate mode by pressing the Calibrate 'soft' key if labeled on the display, then Calibrate 'soft' key; or alternatively by pressing the Menu key, then the Calibrate 'soft' key.
2. Select the type of trim (O/C Pri, S/C Pri, O/C Pri-Sec OR S/C Sec)
3. Clip the leads as required for the type of trim being carried out.
4. Select the required frequency range. Spot trim provides a correction at the currently selected frequency only.
5. Repeat step 3 to 5 until all required types of trim are completed.

6.1.6 Set up measurement

The PMA3260P sets up measurement conditions using the GPIB commands in place of the front panel keyboard entries. See section 6.6.7 for details.

Press "Show Setup" if the setup conditions are not displayed.

Press "←" and "→" keys to move the main cursor (highlighted item) to the measurement condition which is going to be changed.

Press "↑" and "↓" keys to toggle the functions or to step along the predetermined steps. Alternatively the keypad can be used to enter the required measurement conditions. When data is keyed in, the Analyzer will search for the nearest available AC frequency, level or DC bias. Refer section 6.2.12 for more details about the data entry.

Press and hold cursor keys to repeat and speed up the action.

6.1.7 Impedance mode

6.1.7.1 PMA3260P

The PMA3260P supports Impedance mode and a control program must be written. Please follow the PMA3260A procedure substituting keyboard entries with GPIB commands. If a component could be damaged by DC bias current it is good practice to use the :BIN:BIAS OFF command. See section 6.6.7 for details

6.1.7.2 PMA3260A

If the component could be damaged by a DC bias current, ensure that the bias is not on; the associated LED should be extinguished. Press the Bias button to turn it off if necessary. The following steps will give first-time users some ideas about how to get measurement results.

1. Plug into the Analyzer primary sockets the appropriate set of leads; match colors. Connect a test item (e.g., a resistor or a capacitor).
2. Carry out trimming as described in section 6.1.5
3. Press Menu key. Select IMPEDANCE.
4. Select 'AC Meas.' if 'Rdc Meas.' was highlighted.
5. Press 'Hide Scale' if Scale and limits are on.
6. Press 'Show Setup' if the setup conditions were blanked on the LCD.
7. Set AC level 1V, frequency 1kHz, DC Bias 0A OFF, Range Auto, Speed Med, ALC off.
8. Use L/C/Z to select a major parameter. Use Q/D/R to select a minor parameter.
9. Press 'Trigger' to get a single shot measurement. The results are shown in big characters.
10. To make continuous measurements press 'ENTER' or Key in code 19.
11. Press 'Rdc Meas.' to make a Rdc measurement. Note that the setup conditions decreased to only two items and the equivalent circuit symbol changed. To make continuous measurements hold either the 'Trigger' key or 'Rdc Meas.' for more than 2 seconds and release.

6.1.8 Transformer mode

6.1.8.1 PMA3260P

The PMA3260P supports Transformer mode and a control program must be written. Please follow the PMA3260A procedure substituting keyboard entries with GPIB commands. See section 6.6.7 for details

6.1.8.2 PMA3260A

Use two sets of Kelvin clip leads, matching colors on the front panel. Active connections depend on the type of tests and will be indicated by the 8 LED's above the BNC connectors.

1. Carry out trimming as described in section 6.1.5.
2. Connect primary and secondary leads to the appropriate transformer windings.
3. Press Menu key. Select TRANSFORMER.
4. Press Show Setup if the setup conditions were blanked on the LCD.
5. Set AC level 1V, frequency 100Hz, Equ cct Auto, Range Auto, Speed Slow, ALC off.

6. Press top 7 'soft' keys to measure indicated parameters of a transformer. Hold any of these keys for more than 2 seconds to make repetitive measurements.
7. To gain familiarity with this mode try changing the setup conditions and note the changes in measured values.
8. Different test conditions may be entered and stored for the various test types. To make all test conditions common, press "MENU", select the "INSTRUMENT STATUS" 'soft' key and change Test conditions from Non-global to Global. See section 6.2.13 for details.

6.2 Advanced Usage

6.2.1 Basic theory

A passive linear complex circuit presents to alternating currents as an impedance which is a function of frequency. At any one frequency, the impedance can be represented by two components - resistance and reactance - or as a polar function having magnitude and phase angle. The reactance may be inductive or capacitive corresponding to +ve or -ve phase angles respectively in the polar configuration. The theoretical values of the components for extremes of frequency may not be practically realizable, but the following definitions hold:-

- a) Polar parameters are impedance (Z) and phase angle (θ).
- b) The impedance may be represented by either a series or parallel circuit - a resistance (R) and a reactance (X).
- c) Current passing through the reactance results in stored energy, but current passing through the resistance results in dissipated energy. These two energy terms are related by the quality factor Q or dissipation factor D as defined below.
- d) For the series case $R = Z \cos(\theta)$ and $X = Z \sin(\theta)$

$$\text{where } Z = \sqrt{R^2 + X^2}$$

$$\tan(\theta) = X/R \quad = \quad Q = 1/D$$

- e) For the parallel case

$$R = Z / \cos(\theta) \quad \text{and} \quad X = Z/\sin(\theta)$$

$$\text{where } \frac{1}{Z} = \sqrt{\frac{1}{R^2} + \frac{1}{X^2}}$$

$$\text{and } \tan(\delta) = X/R \quad = \quad D = 1/Q$$

- f) For the energy terms:-

$$Q = X/R \quad (\text{series})$$

$$\text{or } Q = R/X \quad (\text{parallel})$$

$$\text{and } D = 1/Q$$

g) For inductance's,

$$X = \omega L$$

h) and for capacitance's,

$$X = \frac{-1}{\omega C}$$

where $\omega = 2\pi f$ (frequency) and the '-' sign represents a voltage phase lag with respect to current as opposed to a leading phase for inductance's.

Diagrams representing these relationships are in Fig. 6.4.

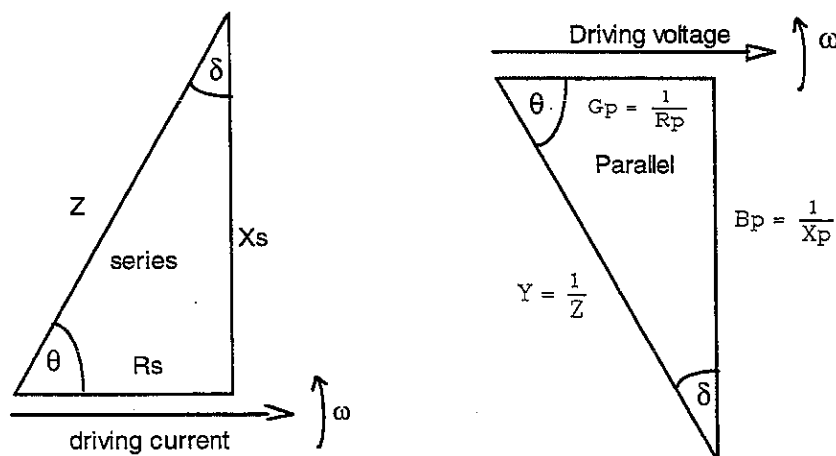

$$Q = \frac{X_s}{R_s} = \tan(\theta)$$

$$Q = \frac{1/X_p}{1/R_p} = \tan(\theta) = \frac{R_p}{X_p}$$

$$D = \frac{R_s}{X_s} = \tan(\delta)$$

$$D = \frac{1/R_p}{1/X_p} = \tan(\delta) = \frac{X_p}{R_p}$$

Figure 6.4 Impedance/Admittance Vector relationships

6.2.2 Front Panel Connections

The Analyzer has two sets of four front-panel sockets for screened cable connections to the unknown component or test fixture. In each case, the outer connection provides the screening and the inner is the 'active' connection. The innermost pair of panel connectors carry the signal source (Orange) and the current return (Red) signals, while the outer pair serve to monitor the actual voltage at the unknown, excluding any Voltage drops arising in the source and return leads.

Measurement connections may be 2, 3 or 4-terminal. Choose 2-terminal for non-critical work, the guarded 3-terminal arrangement for in-circuit and high impedance measurements, and the 4-terminal for low impedance work. A guard-wire at ground potential is available for guard or screen connection.. Choose frequencies to minimize extraneous effects if measuring small impedance's.

- a) Impedance's (at test frequencies) within 100 Ω and 10k Ω are suited to 2-terminal connection. Unscreened leads should be shorter than approximately 15cm long. Longer leads should be separately screened; use a common connection of both braids ('RED' and 'ORANGE' leads) at the test item end. The crocodile clip accessory 1505 is recommended.
- b) 3-terminal connections remove the effect of shunt capacitance of the connecting leads. The common point of the shunting components should be connected to the common point of the braids on the 'RED' and 'ORANGE' leads. The crocodile clip accessory 1505 is recommended, this has an additional GREEN wire (with a crocodile clip) for use as a common connection.
- c) 4-terminal connection circumvents series resistance of the leads, and diminishes series inductance effects. Stable lead positioning is important when measuring low value inductors. Long leads worsen series errors. The Kelvin clip-lead accessory A40100 is recommended.
- d) The measurement connections to transformers are simplified by providing separate primary and secondary connections. These are automatically reconfigured by the instrument to suit the selected test mode. The tell tale LED's indicates which BNC connections are active in each case.
- e) Braid screening of the 'RED' and 'ORANGE' leads should be joined at the test item end. Connect the common point to component guards and/or screens. The 'BROWN' and 'YELLOW' leads' braids must NOT be connected at the item end. All the braids are earthed internally at the instrument end. The Kelvin clip leads accessory type A40100 incorporates these connections and has a fifth (GREEN) wire and clip for use as a common connection.

6.2.3 Manual range selection

The PMA3260P sets up range selection using the GPIB commands in place of the front panel keyboard entries. See section 6.6.7 for details

Manual range can be held by selecting any range number except Auto. Manual ranging for different type of tests is variable, i.e. 7 ranges for AC impedance measurements and 3 ranges for Rdc measurements. The range number can be keyed in when range item is highlighted. The "↑" and "↓" keys toggle between Auto-range and range hold. The present range is indicated by a number at the top left corner of the display. The lowest or highest limits associated with the selected measurement parameters and range are displayed if setup is on.

6.2.4 Automatic Level Control(ALC)

With "ALC on" selected, the ac drive voltage (or current) at the unknown component is automatically maintained at the selected level. For turns ratio measurements on transformers, this refers to the primary winding. For single shot measurements, the level is not adjusted until the measurement is triggered.

A maximum drive level of 10Vrms with a source impedance of 50 Ω is available; giving up to 200mA drive into a short circuit or low impedance. If the requested level cannot be achieved, measurements will be performed at the

highest available level, with a displayed indication of that level. The constant voltage ALC function may be used for impedance's above 0.1Ω .

Where many similar components are to be measured, the level may be fixed after measuring the first device, by selecting "ALC hold". This will also hold the impedance range selection. This setting is recommended for fastest operating speed when using automatic handler systems.

Where drive level is not critical (e.g. for interwinding capacitance) "ALC off" may be selected. In this case the unloaded open circuit voltage (or short circuit current) is equal to the selected level; no measurement of actual level at the test leads is available with this setting.

Hint:

Select AC current drive when measuring small coils or low impedance devices. Select AC voltage drive when measuring capacitors or high impedance devices.

To select the AC drive mode highlight AC drive level and type in required level followed by 'V' or 'A' units.

6.2.5 Measuring Small value inductors

The analyzer measures the difference between the inductance of S/C trimming and the test item fitted in the same location. Therefore stable lead arrangements are essential for low inductance measurements; use of the component fixture, accessory 1006, is recommended. When using the fixture, S/C trim is achieved by placing a wire across the jaws.

NB A 5cm length of 1mm wire has an inductance of $0.05\mu\text{H}$

A 5cm length of 2mm wire has an inductance of $0.04\mu\text{H}$.

Always use series configuration and where possible, measure at 100mA as this is the signal used during trimming.

It must be appreciated that when an inductor is measured at a frequency much lower than that for which it was designed (e.g. an h.f. choke tested at a.f) it will tend to behave as an inductive resistor. In these circumstances, the inductance measurement accuracy is widened by the factor $(1 + 1/Q)$. The value of this factor can be determined by using the Q feature.

6.2.6 Measuring Air-cored inductors

Air-cored coils are particularly susceptible to supply frequency pick up. For this reason, keep them well clear of power transformers and whenever possible, measure at 10kHz. If low-frequency measurements are required, and trouble persists, use SLOW setting. For best measurement accuracy keep air-cored coils away from any metal object.

6.2.7 Iron-cored inductors

Measurement accuracy, in part, depends on the linearity of the test item response. Gapped cores usually give good linearity. The level and frequency can be chosen to suit the application.

Un-gapped cores always cause non-linearity. Inductance usually rises with increasing flux level until saturation is approached. Once saturation is reached, the inductance falls rapidly as drive level continues to rise.

Non-linearity's arise from the curved nature of the V/I characteristic of iron-cored coils. The analyzer filters out the distortion, consequently it measures the integrated value of the curved characteristic, see Fig. 6.5.

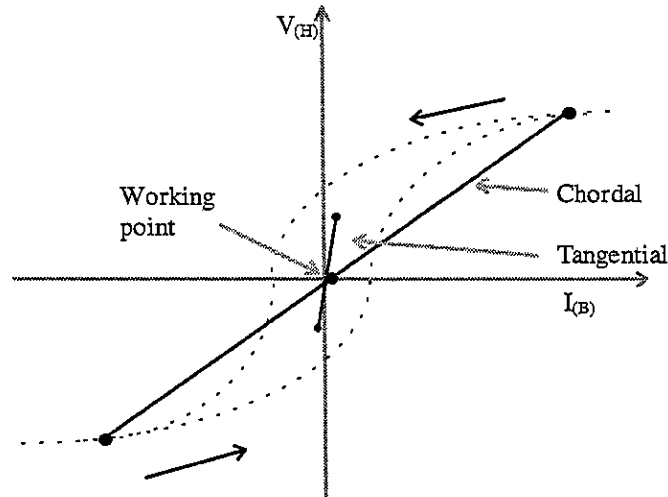

Figure 6.5 V/I Characteristic of Iron-cored Coils.
Measurement is integral of curve between
chordal and tangential values

Iron-cored inductors, including transformers, are susceptible to disaccommodation arising from electrical, magnetic, mechanical and thermal shock; any of which can produce transient or permanent change in inductance. The effect is worst in un-gapped iron-cored inductors at low drive levels. Obviously the shocks can be caused by large changes in level of the driving signal, it is therefore advisable to change the drive level in small increments. The transient changes have long recovery time-constants, so successive measurements (at the same conditions) on a shocked inductor, will show unidirectional changing values. The time taken for the overall change of level, will depend on the component itself and the accuracy required.

The instrument uses low power levels. High operational flux conditions are beyond the specification but high level performance can be indicated using a combination of AC drive and DC bias, see Fig. 6.6. This technique allows, for example, flux saturation levels to be found. Note that an external safety link must be fitted (on the rear panel) for bias operation, see section 6.2.8.

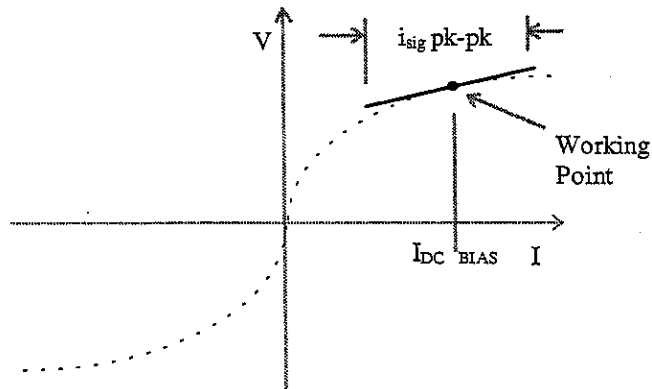

Figure 6.6 High Flux measurement
Small i_{sig} : Large $I_{DC BIAS}$

Pick-up of power-supply frequency can be minimized by avoiding strong external fields (this includes keeping device-under-test away from instrument) and by grounding the core. (There is a ground connection with the clip leads.) Effects of the pick-up can be minimized by running at SLOW speed and avoiding the local power-supply frequency.

6.2.8 Internal DC bias

A programmable internal supply can provide up to 1A DC bias current which is injected in parallel with the AC drive signal.

The safety interlock to the Analyzer **must be fitted** (on the rear panel) whenever the internal bias facility is to be used. Before measuring inductors which may be damaged by DC bias e.g. tape heads, microphone inserts etc., remove this interlock as a safety precaution. If **BIAS ON** is selected with the safety interlock absent, the message 'Bias Interlock' is reported. For further information refer to section 6.9.1 'SAFETY INTERLOCK'.

The instrument changes current levels in a ramped fashion. When a steady level has been achieved the message:-

"Setting DC Bias"

is extinguished. Ranges 6 and 7 are not available with DC bias.

Disaccommodation occurs with iron-cored inductors, see section 6.2.7

The maximum permissible bias induced DC voltage drop depends on the AC drive level. Avoid 'bottoming' the combination of bias and drive signal. When the sum of DC peak and AC exceeds the dc compliance limit (20V limit) then the message :-

"Excess Voltage Drop"

is displayed and no measurements are possible. If this condition persists for more than 10 seconds then BIAS OFF will be selected automatically to minimize any possible operator hazard. The internal bias supply is unregulated so that a higher compliance figure will be available except when the incoming supply is at its minimum value.

Note that use of the DC bias facility inherently reduces the measurement accuracy.

When operating with voltage drive, it is possible to select conditions giving AC current values very small compared with the DC current bias. This situation can give rise to excessive measurement errors or noise. To obtain the stated accuracy figures, the rms AC current should be not less than 1% of the selected DC bias value. This current can be calculated, or measured directly as a minor term with Z selected. For very high impedance inductors, it may not be possible to achieve the required conditions, in which case the highest available drive voltage must be selected. Note that when investigating the permeability of inductor cores it is the sum of DC current and peak AC current that can cause saturation. The use of small AC signals will generally give realistic results.

6.2.9 Transformer mode

The Transformer Mode is designed for making magnetism measurement tasks easier. Two sets of Kelvin clip leads can be connected to the primary and the secondary of a transformer simultaneously. A single key stroke will re-configure the required preset test conditions, configure the connections and trigger a measurement. This greatly simplifies the reconfiguration.

Use crocodile clip leads for transformer measurements. Connect the primary leads to primary and the secondary leads to secondary. 2- or 4- terminal connections may be selected. 4-terminal operation is recommended if the primary impedance is particularly low. ALC function can be turned on if accurate level control is required.

Figure 6.1 shows the display of the transformer mode. Seven different tests can be carried out from the soft keys. Their measurement conditions are stored separately if the non-global mode is selected. One exception is that Leakage(Pri) and Leakage(Sec) tests share the same measurement conditions.

Turns Ratio can be displayed as N_p/N_s or N_s/N_p . When maximum resolution is required, choose the display which is greater than unity. The value displayed is the ratio of measured voltages, hence non-integer results are likely. Trimming and high frequency lead compensation are not required for Turns Ratio measurements.

If a negative reading occurs when measuring turns ratio it implies a reverse connected winding. Check the winding sense convention.

A secondary turns (N_s) can be displayed. This requires the primary turns (N_p) to be preset via keyboard.

For accurate measurements on turns ratio software correction is employed when the primary impedance is high (typically $>50\Omega$). A transparent primary leakage measurement is performed before the turns ratio measurement. As this involves closing and opening relays inside the 3260, normal repetitive measurements are disabled with the correction algorithm operating. This function is NOT automatically performed by the instrument. Instead, the user must set it ON/OFF and define whether the transformer is a Normal type (floating secondary) or an Auto-transformer (one end grounded) as this affects the loading corrections. For local operation this selection is in the Instrument Status page. Code 14 to 16 are used for these selections as well. Refer Section 6.4.1 for code function

descriptions. If the primary impedance is low, it is highly recommended to turn the turns ratio correction OFF.

For step-up transformers, the measured secondary voltage is limited to 10V_{rms}.

Constant current drive is not provided for turns ratio measurements.

6.2.10 Handler mode

The handler mode reconfigures the front panel connections so that this instrument is compatible with many existing 4-terminal fixtures and scanners. For the PMA3260A the layout of the screen is similar to that of the impedance mode with addition of turns ratio. The analogue scale is not available in this mode.

The connections from the 3260 to the 4-line scanner are as follows:

Handler function	Connection to 3260
Drive high (orange)	Primary orange
Drive low (red)	Primary red
Sense high (yellow)	Secondary orange
Sense low (brown)	Secondary red

Due to the different lead configuration, O/C trim, S/C trim and HF lead compensation can no longer share with other modes. The stored self calibrate values are valid for all modes and all type of tests, but the trim and HF lead compensation are specific to this mode only. Access the HANDLER CAL MODE via HANDLER MODE to perform the necessary trim and calibration.

Turns ratio measurements in this mode are made under 2-terminal operation so the effects of connection leads cannot be removed. In essence the effects of measurement lead impedance and transformer shunt impedance cannot be avoided.

6.2.11 Self-capacitance and resonance

Self-capacitance resonates with inductance at a frequency f_0 . At frequencies below resonance, the effective inductance is increased. Above resonance the impedance becomes capacitive, giving a negative inductance reading. The value of each of the two L components in the expressions below, may be either positive or negative. The signs must be included with the values.

To establish the effect, measurements must be made at two frequencies. If inductance's L_1 and L_2 are measured at two frequencies f_1 and f_2 near resonance (in parallel representation), then the self-capacitance is given by:-

$$C_0 = \frac{(L_2 - L_1)}{L_2 L_1} \cdot \frac{1}{(\omega_2^2 - \omega_1^2)}$$

The resonant frequency is given by:-

$$f_0 = \sqrt{\frac{f_2^2 L_2 - f_1^2 L_1}{L_2 - L_1}}$$

6.2.12 Data entry keyboard PMA3260A Only

A user-friendly editor is built into the instrument, which takes data entry via the keyboard.

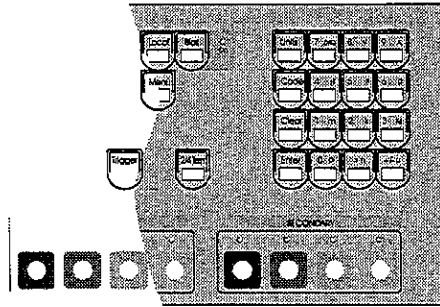

Figure 6.7 Data Entry Keypad

The data-entry keyboard, illustrated in Figure 6.7, uses a multi-function key-set permitting manual entry of data values, measurement units and control codes. The layout for digits keys is a common arrangement for pocket calculators but the 'UNITS' key has a 'shift' purpose. When it is pressed the numeric keys change roles to units or multipliers. The alternative roles are:-

- a) Top row; MINOR TERMS 'D/Q' (toggle between them)
 - Change to voltage or current drive by keying the drive level followed by 'V' or 'A' units.
- b) Next row; measurement units 'H', 'F', 'W'.
- c) The other two rows have normal value power multiplier symbols:-

Mega	10^6
Kilo	10^3
milli	10^{-3}
Micro	10^{-6}
nano	10^{-9}
pico	10^{-12}

The keys in the left-hand numeric column are single function:-

- d) 'UNITS' key equates to 'shift'. Use it prior to keying a unit or multiplier e.g. H or m.
 - Terminate mode with 'ENTER', 'CLEAR' or 'I'.
- e) 'CODE' implies a code number to follow; 'ENTER' terminates the mode. See section 6.4 for definitions.
- f) The 'CLEAR' key erases any entry made since last use of 'ENTER'. The previous stored data won't be changed. The 'CLEAR' equates to the 'Esc' key on a computer. Pressing the 'CLEAR' key always drops to the higher layer of the embedded menu structure.

- g) Pressing the 'ENTER' key accepts the entry just made (echo in the data line), given that the present mode permits data entry.
- h) When the editor is called up, the left cursor key "i" functions as BACKSPACE key. It backspaces numeric entry, multiplier and units. In this mode, repeat function is not active when "i" is pressed and held. Other cursor keys are disabled.

For the majority types of data entry, their units are obvious and predetermined so the unit key entry is prohibited.

The +/- key may be used before or after a value to change its sign. For numbers that are positive only, this key is disabled.

Warning!

Keyboard data entry inhibits measurement. A leading decimal points is unobtrusive; easy to overlook if keyed inadvertently; the analyzer will wait for more data. Keyed data should be terminated or CLEARed.

Examples of keyed sequences (characters in []):-

Example 1: Supply the analyzer with a value of 27.39mH.

(Assume that the Major High item is selected in Impedance Mode)

[.] [0] [2] [7] [3] [9] [UNITS] [H] [ENTER]

or

[2] [7] [.] [3] [9] [UNITS] [m] [H] [ENTER]

Notice that at U the cursor changed to the full height and then is overwritten by m.

If a mistake is made in a sequence, before pressing 'ENTER', press '⇐' to backspace the error or press 'CLEAR' to restart the section.

Example 2: Set the frequency to 100kHz (Assume Freq. is highlighted.)

[1] [0] [0] [0] [0] [0] [ENTER]

or

[1] [0] [0] [UNITS] [k] [ENTER]

or

[.] [1] [UNITS] [M] [ENTER]

6.2.13 Global and non-global measurement conditions

The measurement conditions for different types of test are stored uniquely. I.e. for a different test, it is possible to have a completely different measurement environment.

```

IMPEDANCE (AC)          freq.   = 1kHz
                          Level   = 1V
                          Range   = Auto
  
```

```

TRANSFORMER L+Q freq.   = 100kHz
                          Level   = 100mV
                          Range   = 6
  
```

These test parameters can be set up in the above individual fashion; 'NON GLOBAL' set up. However, it is often useful to set one or all parameters, for all measurements to the same value at the same time; a 'GLOBAL' change

The measurement conditions for different types of test are stored separately in the non-volatile RAM. There are 12 type of tests, therefore 12 blocks. When a type of test is changed, the corresponding block of stores is copied into the working variables and the hardware is set up.

The 12 blocks are as follows.

```

AC types:      Impedance AC
                Transformer L+Q
                Transformer ratio
                Transformer leakage inductance
                Transformer inter-winding capacitance
                Magnetizing current
  
```

```

DC types:      Impedance Rdc
                Transformer Rdc (Pri)
                Transformer Rdc (Sec)
                Insulation (Pri-Sec)
                Insulation (Pri-GND)
                Insulation (Sec-GND)
  
```

When the GLOBAL is selected via either the Instrument Status mode or GPIB, the global measurement conditions (which are stored in the working variables) will be applied to all possible type of tests and all of the above memory blocks are not updated until the Non-GLOBAL is selected. When the type of test changed from one to another, the above blocks are not copied to the working variables if GLOBAL is set.

For better understanding, Figure 6.8 shows the relationship among the blocks, working variables and hardware images and how they communicate each other.

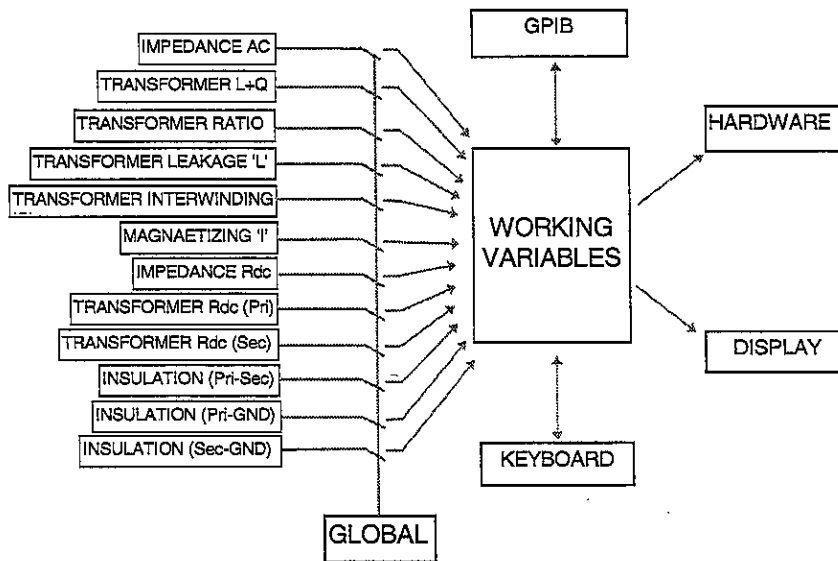

Figure 6.8 The relationship between Non-Global blocks, Working variables and hardware

6.2.14 Percentage and absolute limit display PMA3260A Only

LIMIT measurements are incorporated in the Impedance Mode via the scale function. These are displayed in either of two forms - percentage or absolute. The limits and nominal value have to be entered via keyboard.

The high limit value must be higher than the low limit value. 'Crossed-over' limits are not acceptable and will be exchanged when they are stored in the non-volatile memory.

A nominal is required only for percentage measurements. Symmetric limits will normally be used, however, asymmetric percentage limits can be established. Percentage and absolute limits are stored separately and are therefore independent. Limits for percentage may be keyed in by pressing the 'ENTER' key twice when highlighted. A soft key "Save Nom" is provided to save the measurement result as the nominal.

Measurement parameters (L, C, R, etc.) and units (mH, Ω , etc.) for HIGH, LOW and NOMINAL in the LIMITS mode are compared with those used for the MAJOR and MINOR terms in the IMPEDANCE mode. The message "Units mismatch" is displayed if the settings do not match either.

The Analog Scale provides a visual representation of measurement results in the form of a horizontal bar of varying length. This function, which is useful for adjustment of preset components, is available only in IMPEDANCE mode and is enabled/disabled by the "Show Scale" / "Hide Scale" soft-key.

The Analog Bar Display incorporates two fixed marks, corresponding to the High and Low limits which are displayed under the Bar. Whenever these limits are entered, the horizontal scaling factor is adjusted accordingly.

Scale compression is applied for values above or below the pass limits, allowing a range of values up to 9 times the pass band to be displayed.

6.2.15 Sequence edit mode PMA3260A

The sequence edit mode enables the operator to edit a sequence program. This mode is aimed at a supervisor who has some computer knowledge and an understanding of component measurement.

The PMA3260P may have Sequence Programs downloaded from the test controller but it is preferable to implement Sequence Programs via the GPIB Controller.

A new program should be generated by first copying a previous one (e.g. in the first instance the default program), this can be used as a template and modified to suit requirements. This can then be saved as a unique program for future reference.

The screen is divided in two halves. The right hand side will show the summary of all test steps. If the list is too long to fit in the window, the window can be scrolled up and down using cursor “↑” and “↓” keys. The left hand side will show all the measurement conditions of the current test step. If the cursor is in this side, the conditions can be easily changed or edited. Fig. 6.9 shows an example of the LCD screen.

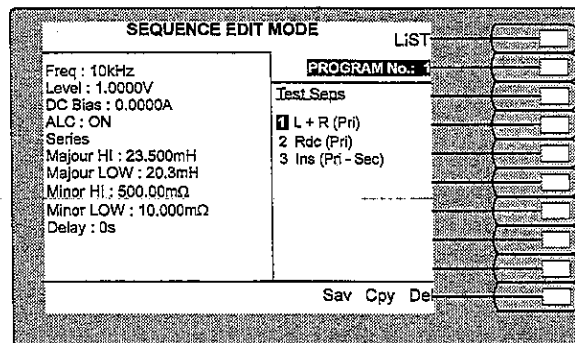

Figure 6.9 Typical Sequence Edit Mode Display

1. To load a program press “MENU” and “SEQUENCE EDIT”. A program will be displayed with its number highlighted.
2. Press the bottom ‘soft key’ until “COPY” is highlighted and then press “ENTER” on the keypad followed by a new program number and “ENTER” again. If no programs are stored, then a default will be loaded automatically as program 1.
3. Press “←” or “→” to highlight the top ‘test step’. If this *is needed* anywhere in the new program use the “↓” key to go onto the next test step.
4. If this step is *not needed* then press “ENTER”. The highlight will then move to the left hand display.
5. Using the “↑” and “↓” keys highlight another required measurement and press “ENTER”. This will appear on the right hand list as the new test step.

6. When there are no more *unwanted* steps in this list it is necessary to copy an existing line.
7. Toggle the bottom soft key until "ADD" is highlighted and press "ENTER". This will duplicate a test step which should be edited as required.
8. Repeat steps 4 - 7 until all required measurements are listed as test steps. These will be automatically re-organized in into the fastest suitable sequence for the instrument.
9. If more test steps are listed than are required, the remainder can be deleted. Using the "↑" and "↓" keys highlight the spare steps and select 'DEL.' by toggling the bottom soft key. Press "ENTER" followed by the top soft key 'CONFIRM'
10. Using the "↑" key highlight the top line of the program, press the "←" to highlight the left side of the display giving setup parameters.
11. Using the "↑" and "↓" keys select a line showing setup conditions which require alteration and key in the new value using the key pad. Terminate with "ENTER".
12. Repeat step 11 until all conditions are set.

NB. ALC.(Auto Level Control) toggles on/off using "ENTER".

SPEED, SERIES/PARALLEL and settling delays toggle using "ENTER".

Range '0' gives autorange.
13. Press "⇒" to highlight the right hand side of the screen.
14. Press the soft key 'Program No.'. Toggle the bottom soft key until 'Save' is highlighted. Press "ENTER" followed by the top soft key 'Save'. This double response is needed when entering or deleting and acts as protection of existing programs.
15. To select an existing program follow steps 1 and 2, but use the program number required, instead of the new program number.

The 'soft key' "LIST" provides a program list of program numbers and their size (in bytes), total number of programs and how many bytes left in the allocated memory. If the list is too long to fit in one screen, "-MORE-" prompts the operator to press any key to see the next screen until the end of the list is reached. Then pressing any key will revert back to editing mode. The list is in the order of memory locations. A code function is available to list programs without regards to the active windows.

All other soft keys are disabled.

When the "Program No." window is active, pressing up or down cursor keys will scan the sequence program memory (load the programs in turn and display them) in numeric order. Pressing "ENTER" will allow a specific program to be loaded. *The processor will detect if the loaded program has been edited or not. If it has and the operator is going to load another program to view or edit, the instrument will ask the operator to save or abort the present program.* Deleting a program function can only be applied on the current program to avoid accidental operations. Copying a program cannot overwrite any existing ones for the same security reasons. Before loading a program, the CRC signature is checked. If the program is corrupted, it is deleted with a warning message.

The working program can be explicitly saved by a code function. Another code function will load a specified program.

No Percentage limits are provided in the sequence mode.

The list of "Test Functions" are:

- L + Q (Pri)
- L + R (Pri)
- C + D (Pri)
- Z + θ (Pri)
- Ns / Np (sec)
- Leakage L (Pri)
- Leakage L (Sec)
- Cs - p (Sec - Pri)
- L + R (Sec)
- Rdc (Pri)
- Rdc (Sec)
- Ins (Pri - Sec)
- Ins (Pri - GND)
- Ins (Sec - GND)

For any test function associated with a secondary winding, the line editor will request the secondary number.

If a new test step is added, all the test conditions which applied on the corresponding test function in "Transformer Mode", "Impedance Mode", etc. are copied across. The operator can then modify them.

Automatic sorting function of test steps will provide any test step added in a correct order:

e.g. Pri, Sec1, Sec2,

In the sequence edit mode the pop-up window will display error messages and dialogue messages. i.e. Before a program is going to be deleted, a message "Delete working program. Are you sure?" will be displayed in the pop-up window to ask the operator to confirm the action.

If a message is a timed-out one, it will time out or go as soon as the operator touches a key. This does not slow down the front panel operations but gives operator plenty of time to read the messages.

The file format of the sequence test programs is defined carefully. It is very compact so that the maximum number of programs can be stored in the limited memory. The program length is varied according to different test functions, but the maximum length is 36 bytes for one test step.

6.2.16 Sequence run mode

In the main menu, press the “SEQUENCE RUN” soft key to enter sequence run mode. If there are no sequence programs stored the message

“NO PROGRAM STORED, PRESS A KEY TO EXIT”

will be shown. Otherwise, the most recent program used in the memory will be loaded by default. The user can then select other programs. The program select screen is shown in Fig. 6.10.

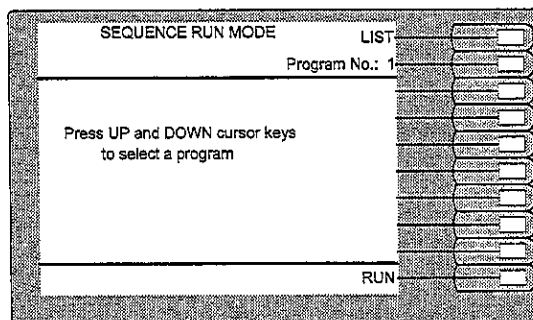

Fig. 6.10 Program Select Screen

Pressing the “↓” or “↑” keys will load the sequence programs in numeric order. The soft key “LIST” gives the list of all programs in the memory. If the soft key beside “PROGRAM No.” is pressed, the line editor will request the program number to be loaded. This is keyed in via the keypad and terminated by “ENTER”. When the supervisor has loaded up a program properly, a code to lock up the ‘CLEAR’ and ‘MAIN MENU’ keys can be implemented after pressing the ‘RUN’ soft key. This disables the operators accidental drop out from the sequence run mode. A non-skilled operator will now be able to run the loaded program.

When the program is running, the screen shows prompts, such as “Connect to SECONDARY 2, press TRIGGER to continue” and the test results (PASS/FAIL). Fig. 6.11 shows an example.

The instrument runs the tests in the order: Pri, Sec1, Sec2,

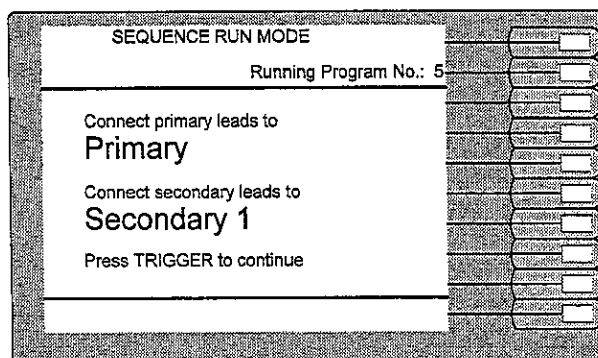

Fig. 6.11 Sequence Run Mode Display

The instrument will remain in the following infinite loop until the supervisor unlocks the keypad and presses the "CLEAR" or "MAIN MENU" keys to abort.

1. Test primary.

Output message "TESTING".

If the test passed, a message

"CONNECT TO SECONDARY n_1 , press TRIGGER to continue"

is displayed.

2. Test secondary n_1 .

Output message "TESTING"

If the test passed, a message

"CONNECT TO SECONDARY n_2 , press TRIGGER to continue"

is displayed.

Repeat this step until all the secondary's have been completed.

Note that the pause to connect the first secondary will only occur if a non zero value has been specified for the Q in the L + Q test.

3. After all the tests to the last secondary have passed, A big

"PASS" will be displayed, then prompt

**"CONNECT TO PRIMARY of next transformer,
press TRIGGER to continue".**

Return to 1.

If a test fails, the test will be aborted immediately. Fig. 6.12 shows an example of the messages and soft key prompts.

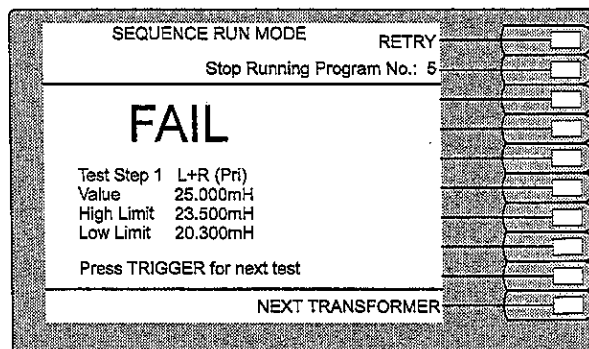

Fig. 6.12 Display when a test failed

On entering the Sequence Run mode and before running a program, keying in code 50 will put the 3260 in the single step mode. It pauses and displays the measurement results together with their limits without regarding to PASS/FAIL results. This is aimed for the sequence program developers to adjust the limits and settling delays for each test. Code 51 or next power-up will reverse it back to normal.

6.2.17 Calibration

6.2.17.1 PMA3260P

Self calibration follows the same procedures as the PMA3260A but uses the GPIB commands in place of keyboard entry.

6.2.17.1 PMA3260A

Self calibration is to find calibration constants for signal processing elements (attenuators, filters, mixer) in the measurement hardware and the signal generation system. It also compensates the component drift with the passage of time.

Self calibration is initiated by the user. When the routine is called, the instrument displays an instruction to the operator to disconnect all measurement leads before proceeding.

As the self calibration corrects for drift in circuit components, it should be called periodically. It is recommended to run the routine every 3 months minimum. If the routine has not been called within this period, a prompt message

To maintain full calibration accuracy, the self-calibrate routine should be run periodically. This calibration is now due. Allow the instrument to warm up for at least 30 mins at its normal operating temperature before running this routine.

Press any key to clear this message.

will be shown at power-up.

If the calibration data becomes corrupted, a different message

Calibration data is lost. To restore full calibration accuracy, run the self-calibrate routine, preferably after the instrument has warmed up for at least 30 mins at its normal operating temperature.

Press any key to clear this message.

will be shown at power-up.

If the self calibration is failed or its data becomes corrupted, the default values which represent a typical instrument will be used. When a measurement is subsequently carried out, "calibrate error" will be generated.

Self calibration also checks the functionality of different parts of the hardware. If an error except error number 255 is persistently reported when doing self calibration, this indicates that the hardware has developed a fault. Please contact your local agent or the factory to seek advice.

6.3 Optional Modules

6.3.1 Insulation Test

The Insulation Test option is available for PMA3260A and PMA3260P. For the PMA3260P substitute front panel key operation for GPIB commands. See Section 6.6.7.

Connections - For manual operation, connect to Primary and Secondary windings in the usual way, using 2 sets of Kelvin clip leads.

For operation with a 4-wire scanner (Handler mode) the scanner relays should be configured as for turns ratio measurement. During Insulation mode operation, set the instrument to 2-terminal operation.

Note that this is a 3-terminal test function. If measuring insulation between primary and secondary windings, any leakage to grounded terminals (e.g. screens or core) will be ignored. Insulation from either winding to ground may be separately measured, in which case primary to secondary leakage will be ignored. If a measurement of total leakage resistance between windings is required, make no connection to the Ground lead.

For each winding, the test voltage is applied to one wire only, as indicated by the front panel LEDs. If 4-terminal operation is selected, this is the brown BNC (voltage sense low). For 2-terminal operation it is the red BNC (drive current return).

WARNING!

Avoid touching the test connections during Measurement or Trimming operations. Although the current is limited to a safe level, there is a risk of electric shock, especially at 200V and 500V test levels. The voltage will be removed within 0.5 second when the test is completed, providing no energy is stored in components connected to the measurement terminals.

6.3.1.1 Trimming

For Insulation mode operation, trimming compensates for any residual leakage currents in the test leads or fixtures. For maximum accuracy the trimming operation should be performed with the test leads connected to the instrument but isolated from each other.

For manual operation, ensure 2-terminal or 4-terminal operation is selected as required for subsequent measurements, then carry out O/C Trim (Pri-Sec) as detailed in section 6.1.5.

For Handler mode operation, select 'Handler Calibration' from the CALIBRATE menu. (From HANDLER mode, press 'CALIBRATE' key to access Handler Calibration directly). Then select the Insulation Trim function. Note that in this case the stored trim values will be applied during 2-terminal Insulation tests, even if the ac impedance and Rdc trimming corresponds to 4-terminal operation.

6.3.1.2 Operation

1. Press the 'INSULATION' key either in the Transformer mode or in the Main Menu to select the Insulation mode.
2. Press 'Show Setup' if the setup conditions are blanked on the LCD.
3. Select the test mode 'Pri-Sec', 'Pri-GND' or 'Sec-GND' as required. Set DC level to 100V, 200V or 500V; Range Auto; Speed Fast or Max.
4. Select display readout - ' μA ' to read leakage current or ' $\text{M}\Omega$ ' to read insulation resistance.

Press Trigger to initiate test. To minimize the risk of electric shock high voltages are applied to the test leads only during testing. For this reason repetitive measurements are cease when the key is released. Alternatively, if the external Trigger input is used (see section 6.9.3), measurements continue only while the input is at logic low level.

If the test current exceeds 1mA it cannot be measured. This corresponds to a minimum resistance of 100k Ω at 100V, 200k Ω at 200V or 500k Ω at 500V. In this case a message 'Current Too Large' or 'Resistance Too Low' will be displayed.

Unless GLOBAL measurement conditions are selected the test voltage and other settings may be set differently for each of the three test types. See section 6.2.13 for further details.

6.3.2 Extended Frequency Option

The Extended Frequency Option is available for PMA3260A and PMA3260P. For the PMA3260P substitute front panel key operation for GPIB frequency commands. See Section 6.6.7.

If extended frequency is installed, maximum operating frequency increases from 500kHz to 3MHz and improved measurement accuracy is obtained in the frequency range 20kHz to 500kHz. In addition, test frequency increments of 1% or better are available over the entire operating frequency range (350 frequencies in each decade).

Frequency Setting - When selecting frequency, the vertical cursor keys "↑" and "↓" may be set to give either coarse steps (10 frequencies per decade) or fine steps (as above). From the Impedance, Transformer or Handler modes use Code 10 to select fine steps or Code 11 to select coarse steps. Alternatively, from the Main Menu select INSTRUMENT STATUS and edit the "Freq steps:" entry using the cursor keys. Note that when a frequency is entered via the keypad or via GPIB remote control the nearest available fine frequency will always be selected.

HF Lead Compensation

For operating frequencies above 500kHz, measurement accuracy is modified by the characteristics of the measurement cables and test fixture and serious errors may occur if the cable length or the fixture are changed. To maintain full specified accuracy with any cable / fixture combination, the 3260 incorporates a

lead compensation routine which should be run whenever the test cables are changed. Ensure that the 150pF transfer standard in kit (part no.4N3269TS) is available then proceed as follows: *MAYBE 100PF*

Ensure that 2-terminal or 4-terminal operation is selected as required. See section 6.2.2.

With the test leads and fixture connected and configured as required for primary measurements perform primary Open Circuit and Short Circuit trimming as detailed in section 6.1.5.

Connect the transfer standard capacitor in place of the short circuit. If using Kelvin clips or other clip leads arrange the leads in a similar position to that used for Short Circuit trimming.

From the Calibrate mode press the HF Lead Compensation soft key. Then press the key labeled 'START'.

The resulting compensation values will be stored indefinitely in non-volatile memory and will be re-applied automatically at power up. If the stored values become corrupted or if the compensation routine was incorrectly run default values corresponding to nominal instrument and test lead characteristics will be substituted. In this case, the display will show 'Calibrate Error' whenever a test frequency >500kHz is selected. A warning message will also be displayed at power up.

6.3.3 Bin Handler Option

The PMA3260A and PMA3260P can both have this option fitted. The PMA3260P uses GPIB commands to setup the Bin commands. See Section 6.6.7.

The Binning Option enables components to be sorted and statistical analysis carried out on cumulated results. An Interface is included to enable tested components to be placed in the correct Bin based on measured values.

There are three basic features with binning – setting the discrimination limits, sorting measured values and displaying the consequent counts.

In the Main Menu a single entry, BINNING, accesses BIN SET, BIN SORT and BIN COUNT with sub-modes if the bin handler option is fitted.

Binning can be done either on an absolute or percentage limits basis. Select BIN SET mode and choose ABS or % as required. The units for the absolute limits and nominal, in percentage mode, are determined by the type of tests selected.

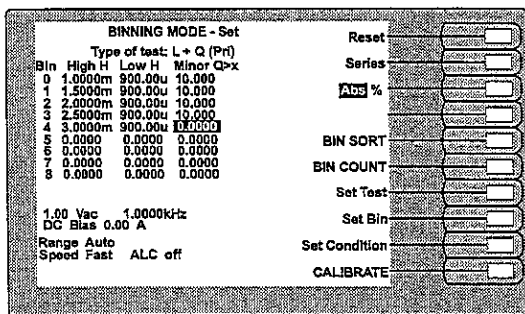

Fig. 6.13 BIN SET - ABS Mode

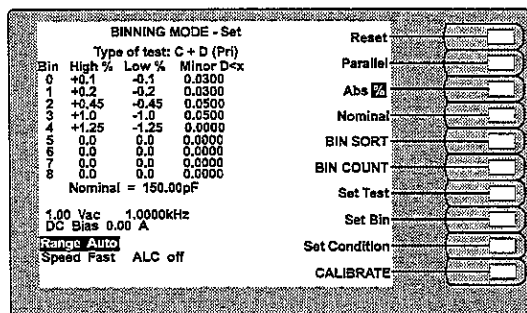

Fig. 6.14 BIN SET - % Mode

Press “Set Test” softkey to show a list of tests (as shown in Fig. 6.14) and select the required test. If the Series/Parallel parameter is required a softkey will appear as shown in Fig. 6.13 or 6.14. In percentage mode a “Nominal” softkey is available to allow its value to be keyed in.

Press the “Set Condition” softkey to move the main cursor to the bottom area and use left/right cursor keys to highlight one item. Change measurement conditions by either keying in new values or using the up/down cursor keys to select the pre-defined steps as in Impedance Mode.

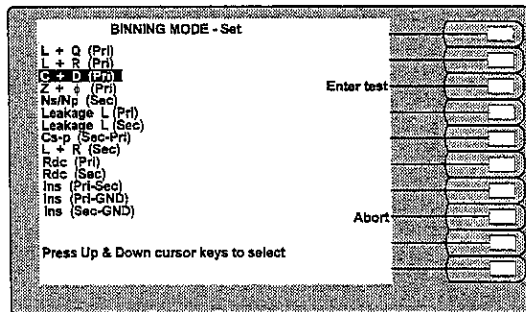

Fig. 6.15 List of tests

Press "Set Bin" softkey to move the main cursor to the set-limit area. Use left, right, up and down cursor keys to highlight one item and then enter the required values via the keyboard.

Each choice (ABS or %) has its own set of limits although there is one common set of bins. Only the selected set is stored if key CODE 40 is entered following a stored number. Unwanted bins can be disabled by setting their values to zeros. Major or minor terms can be individually disabled in the same way. The "Reset" softkey is provided to remove all bin values.

If percentage binning is intended the nominal value should be entered at this point by selecting the "Nominal" softkey then entering the desired value on the keyboard. Note that in % mode, symmetrical limits are obtained by pressing the ENTER key twice.

The binning set-ups can be stored in the non-volatile memory and recalled according to its sequential number. Up to 100 (number 1 to 99 plus set-up 0 for editing) set-ups may be stored. Binning data shares the same internal memory space with Sequence programs. In order to conserve memory for Sequence programs it is recommended to start from setup 1. If all of the 100 possible bin setups are used then approximately one third of the sequence Program memory area will be unavailable.

Code 40 and 41 following 2 digits entry are used to store and recall the binning set-ups. Code 42 displays a list of stored bin set-ups.

Once satisfactory sets of limits have been established test items can be assessed by selecting BIN SORTing mode or BIN COUNTing mode.

Note the following points about BIN SET operations:-

The limits do not have to be symmetrical.

The binning is done by measuring a component and comparing the result obtained with the bin limits in order from 0 to 8.

The limits do not have to be unique. If there are more than one of a particular value, that with the lower bin number will be considered first.

Bin 9 by default is for measurement results outside the limits of bin 0 to 8 inclusive.

The major term result is compared with the High and Low limits. If it does not lie between them, then the search goes immediately to the next bin.

If an insulation test has been chosen the upper limit will be set to infinity and the lower limits will be in MΩ. A lower limit of 0.000 indicates an unused Bin.

The minor term result will only be tested against the minor term limit if

- (1) There is a minor term associated with the test.
- (2) The minor term limit is not exactly zero.

If these conditions are not met, then the minor term is ignored and the component is "placed" in the current bin. Specifying a minor term limit of zero (the default value) provides a way of selectively ignoring the minor term for each bin.

The minor term result will be compared with the limit according to the label displayed at the head of the minor term limits column in BIN SET mode. For all of these labels x represents the minor term limit, '>' means the result must be greater than the limit, and '<' means the result must be less than the limit. If the component meets the minor term conditions, it will be "placed" in the relevant bin; otherwise, it will be tested against the limits of the next bin.

Having selected the test, set up the measurement conditions and limits, you can go to BIN SORT or BIN COUNT mode by pushing corresponding softkeys. Fig. 6.16 is BIN SORT mode. It operates under Single Shot or Repetitive modes.

In use, the screen shows the measurement results, corresponding classification, type of test and measurement conditions clearly. Note the provision of softkeys for direct switching to BIN SET, BIN COUNT and CALIBRATE modes.

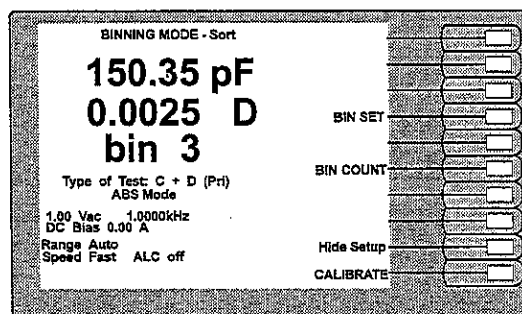

Fig. 6.16 BIN SORT

BIN COUNT (Fig. 6.17) is a data logging mode and operates under Single Shot mode only. It also operates, transparently to the user, when BIN SORT is used in Single Shot mode. The screen displays total data for all bins simultaneously together with a batch total. Each measurement, as made, is allocated to the appropriate bin.

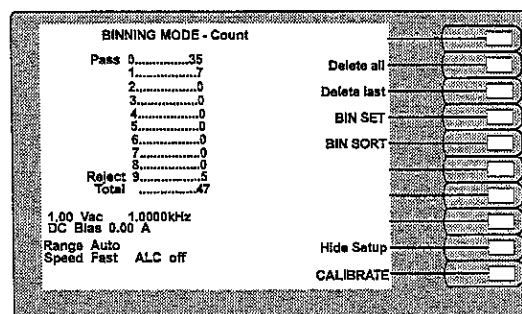

Fig. 6.17 BIN COUNT

All BINning data is stored in non-volatile memory until deleted. Hence the "Delete all" key is used when setting up for a new batch. The "Delete last" key is primarily meant for erasing the measurement result for a wrongly connected

component. When either of these is pressed the user is asked to confirm the delete operation.

The PRINT softkey legend appears on the BIN COUNT display if a printer is connected and printing is enabled (Code 30 from the Main Menu). In BIN SET mode, Code 34 will print the list of the current bin setup. In BIN SORT and single shot mode, measurement results and bin number are printed out if printing is enabled.

6.3.3.1 Bin Handler Interface (BHI)

An external bin handler may be connected via a 25 way D connector at the rear of the instrument (see section 6.9.8 for details). If the option is fitted the instrument will measure a component, sort it into one of the ten bins according to the measurement results and then provide the signals for external bin handling hardware to physically “bin” the component. The interface supports up to ten external bins and provision is made for external bin handler hardware to trigger a measurement directly. A separate PASS/FAIL signal is driven by Impedance and Sequence Run modes with the same handshaking timing.

On power up, the instrument recognizes if the Bin Handler Option is fitted, the BUSY line is taken low, with the BDA and all BIN lines high. Measurements may be triggered by pressing the Trigger key on the front panel or taking the TRIGGER line low. If a measurement is in progress when the unit is triggered the current measurement will be aborted and a new measurement started.

If the external trigger is to be used under GPIB control, then local trigger must be enabled by sending the command “LOC-TRIG ON”.

The BUSY line goes low to acknowledge the trigger and also to indicate that the component between its terminals is in the process of being measured and should not be removed until the BUSY line goes high again. BDA line is opposite logic level of BUSY line. The falling edge of BDA signal indicate the data on the BIN lines is valid.

In Impedance Mode the PASS/FAIL line corresponds to the scale bar PASS/HI or Lo. In Sequence Run mode, PASS/FAIL line is activated at the end of sequence program to indicate a total PASS or FAIL. BDA, BUSY and external TRIGGER lines work in the same way as described above.

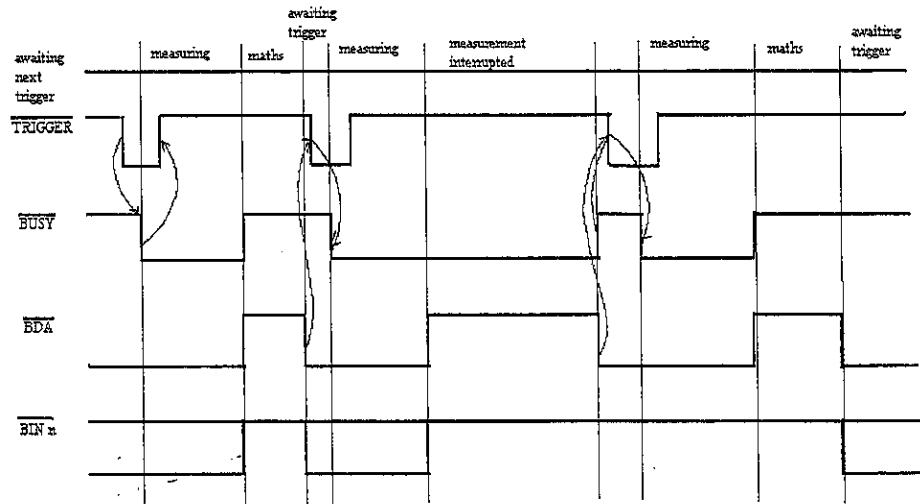

Fig. 6.18 Standard Bin Handler Timing

The two output signal lines BUSY and BDA (Bin Data Available) will at any time assume one of four different states:

6.3.3.2 Null State

The null state is defined as BUSY low and BDA high.

The 3260 enters this state on power-up. When this state is detected by external hardware, it must be assumed that the current signals on the BIN lines are invalid and should be ignored.

6.3.3.3 Ready for Trigger

BUSY is high and BDA is low in this state.

All BIN lines will be unchanged. If the previous state was a null then all bin lines will be high, meaning no bin selected, although BDA suggests that valid bin data is present. When the instrument receives a trigger it will respond by entering the next state.

6.3.3.4 Busy

Both BUSY and BDA are low in this state.

The BUSY line goes low to acknowledge the trigger and also to indicate that the component between its terminals is in the process of being measured and should not be removed until the BUSY line goes high again, when the instrument enters the next state.

6.3.3.5 Not Busy

Both BUSY and BDA are high and all BIN lines are set to high in this state.

The instrument has finished with the component under test, which may be removed and replaced by the next component. However, the instrument has still to sort the component into relevant bin and, as the current bin is being updated, all the BIN lines are made invalid.

If the process has been completed without interruption, the instrument will re-

6.4 Keypad Functions

6.4.1 Code Functions

This section defines the various code functions available. These are only available in the appropriate modes/menus and mainly for the use of a service engineer. Some sections of this manual refer to function codes,

e.g. Section 6.2.16 'Sequence Run mode' refers to a key lock facility.

To action this;

-need to be in the 'Sequence Run' mode

-type [CODE][3260][ENTER]

-keys "CLEAR" and "MAIN MENU" are now locked

-type [CODE][3260][ENTER] to return.

CODE	DESCRIPTION
------	-------------

MAIN MENU

0.1	Display the character set
0.4	Test keyboard
9.1	Clear & setup default values of NON-VOLATILE RAM variables, measurement conditions and trim values.
9.2	Clear sequence programs
9.3	Clear & setup default values of self-calibration and HF lead compensation data
30	Enable printer output
31	Disable printer output
32	Print Factory Calibration Data
33	Future Expansion

STATUS MENU

25	Setting the real time clock
34	Print the status page. Code 30 MUST be entered first.

SEQUENCE EDIT mode

0.30	DIR. Command
0.40	Save the working program
0.50	Load a program explicitly
34	Print the full list of the current program. Code 30 MUST be entered first.

SEQUENCE RUN mode

50	Enter single step mode
51	Cancel single step mode
52	Test step failure message disabled
53	Test step failure message enabled
3260	Lock / Unlock keyboard

IMPEDANCE, TRANSFORMER AND HANDLER MEASUREMENT modes

10	Select frequency fine step up/down
11	Select frequency coarse step up/down
12	Set global test conditions
13	Set non-global test conditions
18	Single shot mode
19	Repetitive mode

TRANSFORMER AND HANDLER MEASUREMENT modes

14	Select Turns Ratio correction for normal transformer
15	Select Turns Ratio correction for auto transformer
16	No Turns Ratio correction applied

BIN SET mode

10	Select frequency fine step up/down
11	Select frequency coarse step up/down
18	Single shot mode
19	Repetitive mode
34	Print the present bin setup. Code 30 MUST be entered first.
40	Store bin setup at a given location in non-volatile memory.
41	Recall a bin setup from non-volatile memory.
42	List all the setup in non-volatile memory.

BIN SORT AND BIN COUNT modes

18	Single shot mode
19	Repetitive mode

6.4.2 Reset

The PMA3260 may be Reset by simultaneously pressing the top soft key and the 2/4 wire key. Once Reset has taken place the unit will require to be trimmed.

6.5 Reference Tables

6.5.1 Default instrument state

Default settings which are stored in the non-volatile RAM are as follows;

GPIB address	Set to address 6
measurement connections	4 terminal
frequency steps	coarse
measurement conditions	Non-global
Menu	MAIN
SET UP view	ON
Trimming values	0
Nominal Unit	H
Major term selection	L
Minor term selection	Q
Measure Frequency	1kHz
AC level	1V
AC Measure	Auto Ranging
DC Measure	Auto Ranging
SPEED	FAST

Impedance mode	AC test
Nominal absolute value	10mH
Percentage HIGH limit	10%
Percentage LOW limit	-10%
Absolute HIGH limit	0
Absolute LOW limit	0
Scale	Percentage mode
scale view	OFF
BIAS	OFF
Bias level	0A

Transformer mode	L+Q (Pri) test
	Series measurement
No. of Primary turns (Np)	1
Turns Ratio	Auto Ranging

Insulation mode	Pri - Sec test
	Auto Ranging
DC level	100v

These settings are stored in the non-volatile RAM are present on first operation. The default settings can, however, be reinstalled by the appropriate code in the main menu, see section 6.4.1.

6.6 GPIB Control

6.6.1 Introduction

The GPIB is a parallel port designed to be used for communication between instruments and control devices such as PCs fitted with a suitable interface card.

GPIB (“General Purpose Interface Bus”) is controlled by various different standards:

- IEEE488.1 Determines the details of the hardware protocols.
- IEEE488.2 Provides detailed guidelines for status reporting and defines a set of common commands to handle fundamental operation of a remote instrument. These include handling of the serial poll register, storage of set-ups and reporting of errors.
- SCPI Ver 1992.0 “Standard Commands for Programmable Instruments” is a proposal for a third level of standards which dictate not only commands for common operations but those for device specific operations e.g. setting frequency or voltage on an output. In addition SCPI is a hierarchical protocol which should allow swift programming of associated parameters. The object of SCPI is to make the users learning curve shallow and painless.

6.6.2 Interface Specification

The IEEE 488.1 bus standard and the IEEE 488.2 code standard are fully supported. The command set has been developed to conform to the SCPI standard.

The IEEE 488.1 functions supported:

SH1	Full source handshake
AH1	Full acceptor handshake
T6	Basic talker, serial poll, talk only, untalk if MLA
TE0	No talker with secondary addressing
L4	Basic listener, no listen only, unlisten if MLA
LE0	No listener with secondary addressing
SR1	Full service request
DC1	Full device clear
RL1	Full remote/local compatibility
PP0	No parallel poll
DT1	Full device trigger compatibility
C0	No controller

6.6.3 Changing GPIB Address

6.6.3.1 PMA3260P

The PMA3260P has a rear panel mounted switch which can set a default GPIB address of 6 or enable a user defined address to be used (0-30).

To change to a user defined address set the GPIB slide switch to the default position and establish communication between the instrument and a GPIB controller. Move the slide switch away from the default position and use GPIB commands to set the new address. See Section 6.6.7 for command details.

Once the GPIB address has been changed any further communication must use the new address.

For a single PMA3260P installation it is recommended that the default GPIB address is used.

6.6.3.2 PMA3260A

Each instrument on the GPIB requires a unique address. In the PMA3260A this is set via the front panel and is stored in non-volatile memory.

In the INSTRUMENT STATUS mode, GPIB address can be changed by either keying a valid number (0-30) or pressing UP/DOWN keys.

6.6.4 Communication Syntax

Commands are sent to the instrument as ASCII strings. The string will potentially contain:

<command> <NULL SPACE><data/parameter> <separator> <command>....<terminator>

e.g.: **ESE 128;*IDN?L*

6.6.4.1 Commands

Commands are ASCII strings. Many commands have both a long and a short forms. No other forms should be used, e.g. the FREQUENCY command:

Legal syntax FREQ or FREQUENCY.

The instrument is **not** case sensitive

Commands can be separated into two groups, *common commands* and *subsystem commands*.

Common commands are generally not measurement related and are used to manage status registers, synchronization, and data storage. Common commands are easy to recognize because they all begin with an asterisk, such as *IDN?, *SRE, and *RST. Common commands are defined by IEEE 488.2

Subsystem commands include all measurement functions and some general purpose functions.

<NULL SPA> Data and commands should be separated by a character such as a null (ASCII 00H) or a space (ASCII 20H) all characters below ASCII 20H are treated as NULL SPA other than 0AH (Line Feed).

Data/Parameter - Data formats are defined by the 488.2 standard. Floating point data is supported as well as several other formats. The principle is “forgiving listening”.

Some commands require mnemonics (specific strings).

Some commands require numeric or alpha-numeric data to follow (e.g. RANGE 4 where 4 is numeric data, SPEED SLOW where SLOW is alpha-numeric data).

If data is omitted, or of an incorrect type, a Command Error is generated. If data is out-of-range, an Execution Error is generated. If the instrument can only find the nearest available data, a Device Dependent Error is generated together with the corresponding Encoded Error Message bit set.

Separators - Commands are separated by semicolons. Many commands can be sent in the same string (max. length 256 characters). Data is separated by commas (where more than one parameter required).

Terminators - When addressed to listen, a line feed (ASCII 0AH) character and/or the EOI line asserted will be recognized by the instruments as a terminator.

Note: When addressed to talk, the instrument response message is terminated with the assertion of the EOI line coincident with the Line Feed character on the data bus.

Hierarchical Commands

SCPI uses a hierarchical structure for subsystem commands similar to the file systems on most computers. This structure is called a command tree. Subsystem commands are distinguished by colon used between keywords, as in :IMP:LEV?

In the command tree, the commands closest to the top are the root commands. Notice that you must follow a particular “path” to reach lower level subcommands.

The following is an example command string:

```
“TRAN:FREQ 1.5E3; LEV 0.5A;ALC ON; RANGE AUTO”
```

TRAN puts unit into TRANSformer subsystem - TRAN is a path name.

FREQ, LEV, ALC and RANGE are all commands operating on the transformer mode (i.e. they are all commands in the transformer subsystem). They do not for example effect settings of frequency in other modes. Note that FREQ is separated from TRAN by a ‘:’ this is used to concatenate commands to paths.

In the following example two roots are used. By beginning a command with a ‘:’ it tells the instrument the following command will be a root (otherwise it assumes subsequent commands are subsystems of the last root used).

```
“TRAN:SPEED SLOW; :IMP:TEST:AC”
```

:IMP is a new root and not part of the transformer subsystem.

It is possible to nest many levels within a path. This varies from instrument to instrument.

Hierarchy Syntax - The following are rules for negotiating the command hierarchy:

- One power-up or reset, the current path is set to the root.
- Message terminator, New Line or EOI, sets the current path to the root.
- When the colon is the first character of a command, it specifies that the next command mnemonic is a root level command.
- When the colon is between two command mnemonics (no spaces in between), the current path is moved down one level in the command tree if the path name is valid.
- A semicolon separates two commands in the same message without changing the current path.
- If a command requires more than one parameter, you must separate adjacent parameters using a comma. Commas do not affect the current path.
- Common commands, such as *RST, *RCL, are not part of any subsystem. An instrument interprets them in the same way, regardless of the current path setting.

One should bear in mind that at each level of the command tree there may be both command names and the path names.

Other syntax rules

That commands will be executed in the order in which they appear in the string.

A command string can contain any number of “query commands”, each returning a response, within a single response string. The commands generating a response can occur anywhere in the command string.

Only commands available in the selected mode will be accepted. Otherwise an Execution Error will be generated. For example, AC frequency cannot be set if Rdc type of test is selected.

6.6.5 Data Output

6.6.5.1 Output Syntax

For each command (query) which generates an output response, a Response Message Unit (RMU) will be generated. This consists of a string of numerics or alpha-numerics, terminated by a semi-colon (if followed by further RMU's) or the terminator (LF+EOI). All characters upper case. (Note: the principle is “Precise talking”.)

6.6.5.2 Multiple Data Items

Some commands will generate an RMU containing more than one item of data (e.g. TRIG will generate major and minor term data). In this case, each item of response data will be separated by comma. Note that the output buffer is 256 characters long. Any data beyond this will be lost.

The above rules ensure that for each query command string sent to the instrument, only one response string is returned; and that responses from a single command and from separate command string can readily be distinguished.

6.6.5.3 Numeric Format

The format of numeric results will correspond to that used for the instrument display, with the engineering multiplier (if any) replaced by an equivalent 10's exponent.

6.6.6 Status Reporting

6.6.6.1 Status byte

The Status Byte is used to summarize information from the other status groups. It is shown in *Fig. 6.19*, which conforms to IEEE 488.2 and SCPI. The status byte can be read by the query command *STB? or by performing a serial poll on the instrument. (These two are identical although the point at which the RQS bit can be cleared is slightly different.)

BIT	Meaning True = "1"
7	Operation Status Event Register summary bit. This bit is true when measurement or trimming, etc. in progress
6	RQS - ReQuest for Service. When the bit in the Service Request Enable mask is set with the corresponding bit in the status register true this will trigger a service request to the controller. MSS - Master Summary Status bit. The version of the request for service bit that appears in the Status Byte.
5	ESB Event Summary Bit. When unmasked by the ESE register this bit will be set whenever the corresponding bit or bits are set in the Event Status Register.
4	MAV Message available. The output queue has data to be read.
3	is a summary bit from Questionable Data. We don't use this bit, so it is always 0.
2	Instrument dependent bit. It is a summary bit of error and instrument status messages. True if any new status information is available.
1	always 0.
0	always 0.

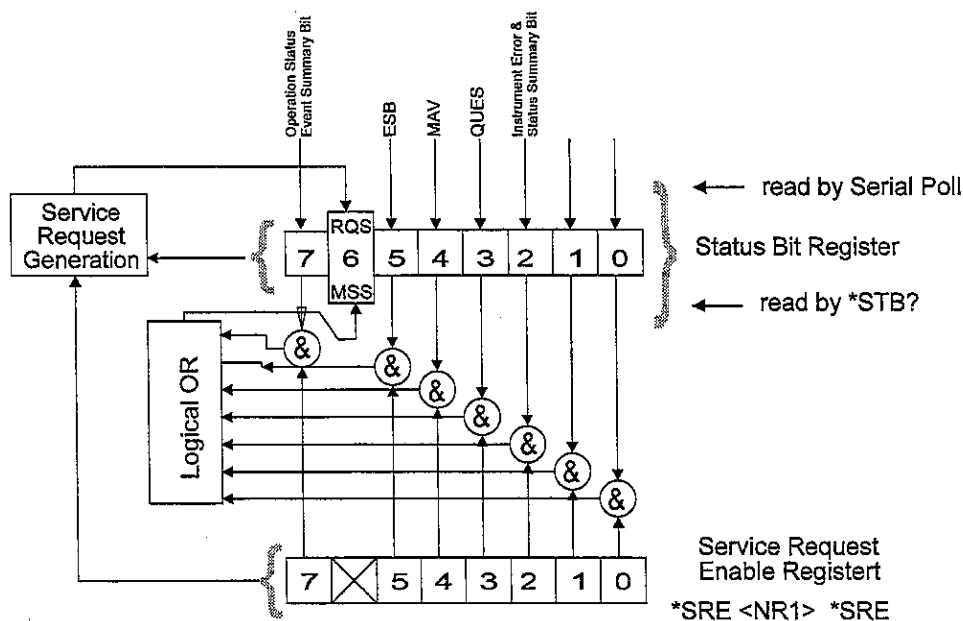

Fig. 6.19 Status Byte Register

6.6.6.2 Service Request Enable Register

The Service Request Enable Register (SRE) is a mask, determining the conditions in which the SBR will generate a service request. It is ANDed bitwise with the SBR and, if the result is not zero, then bit 6 of the SBR is set (see Fig. 6.19). The SRE is set by the *SRE command and read by the *SRE? command.

6.6.6.3 Standard Event Status Register

The standard event status register (ESR) contains the 8-bits of the operation status report which is defined in IEEE 488.2. If one or more event status bit is set to "1" and their enable bits are also "1", bit 5 (called ESB) of the Status Register Byte is set to "1".

Each bit of the standard event status register is shown below.

BIT	Name	Meaning (True = "1")
7	Power On (PON)	True when the PMA3260A power supply has been turned OFF and then ON since the last time this register was read.
6	User Request (URQ)	Not used. Always 0.
5	Command Error (CME)	True if the following command errors occur: An IEEE 488.2 syntax error occurred. The device received a Group Execute Trigger (GET) inside a program message(?).
4	Execution Error (EXE)	True when a parameter following a header of a GPIB command was evaluated by the PMA3260A as being outside of its legal input range or is otherwise inconsistent with the PMA3260A's capabilities
3	Device Specific Error (DDE)	True when a device dependent error (The second category error described in section "Error handling routine") has occurred. Refer to that section for more details.
2	Query Error (QYE)	True when attempting to read data from the output buffer in which no data was present, or when the data was lost.
1	Request Control (RQC)	Not used. Always 0.
0	Operation Complete (OPC)	True when the PMA3260A has completed all selected pending operations before sending the *OPC command

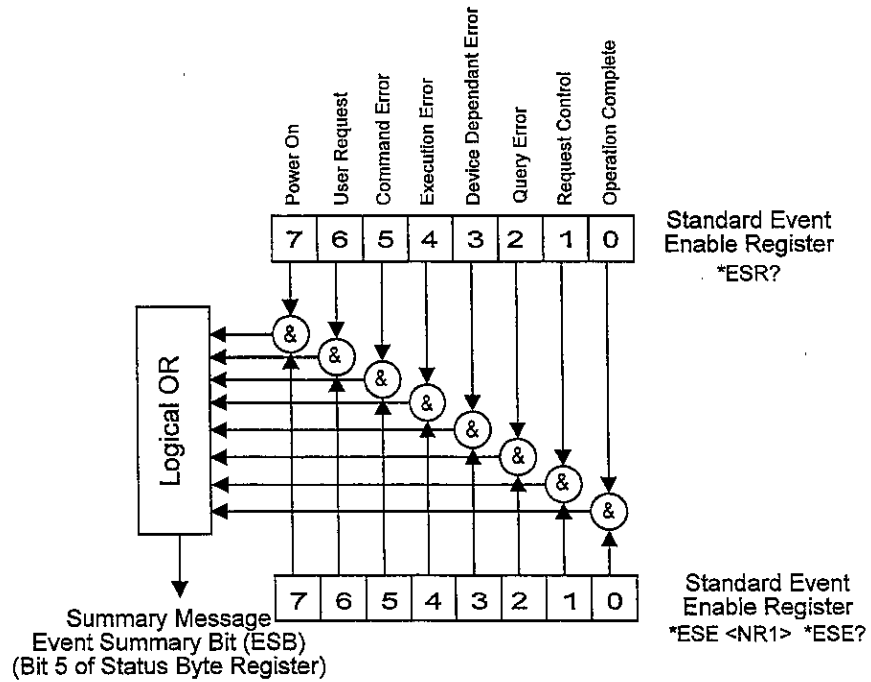

Fig. 6.20 Event Status Byte Register

6.6.6.4 Event Status Enable Register

The Event Status Enable Register (ESE) is a mask, determining the conditions in which the ESR will set Bit 5 of the SBR. It is ANDed bitwise with the ESR and, if the result is not zero, then ESB (Bit 5) of the SBR is set (see Fig. 6.20). Thus any event affecting the ESR can be made to generate a Service Request in conjunction with the ERE and the SRE.

The Event Status Enable is set by the *ESE command and read by the *ESE? command.

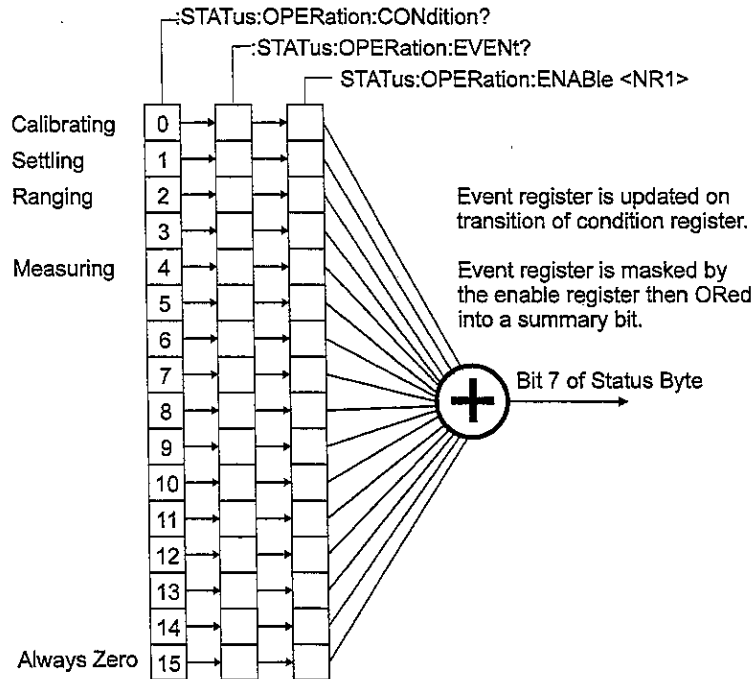

Fig. 6.21 Standard Operation Status Group

6.6.6.5 Standard Operation Status Group

The Standard Operation Status group provides information about the state of the measurement systems in the instrument. This status group is accessed through the STATus subsystem. Standard Operation Status includes a condition register, event register, and an enable register. Fig. 6.21 illustrates the structure of Standard Operation Status.

6.6.6.6 Standard Operation Status Condition Register

This is a 16-bit register gathering information about the state of the measurement systems in an instrument. According to SCPI recommendation, we define:

BIT	Meaning (True = "1")
0	Calibrating bit which is true when S/C trimming, O/C trimming, or calibrating is in progress, and otherwise reset.
4	Measuring bit true when measurement is in progress, and otherwise reset.

All the rest are unused and are 0.

6.6.6.7 Standard Operation Status Event Register

This is a 16-bit register too. Each event bit in the event register corresponds to a condition bit in the standard operation status condition register. According to SCPI recommendation, we define:

BIT	Meaning (True = "1")
0	True when S/C trimming, O/C trimming, or calibration measurement is completed.
4	Bit is set true when single shot measurement is completed.

Other bits are uncommitted and are always 0.

6.6.6.8 Encoded Message Register

All front panel warnings and messages can be monitored over the GPIB. There are also several extra flags otherwise hidden that are of interest to the bus user.

The encoded message query command returns a string of 8 digit hexadecimal number. Each digit represents 4 different errors or their combinations, which can be decomposed easily.

The encoded message format is as follows:

D7 D6 D5 D4 D3 D2 D1 D0

Where D0 indicates range or trim errors

Bit0 = Range Error

Bit1 = S/C Trim Error

Bit2 = O/C Trim Error

Bit3 = Calibrate Error

D1 is reserved for the future expansion.

D2 indicates errors related to ALC operations.

Bit0 = CANNOT SET LEVEL

Bit1 = Sec Level Too High

Bit2 = ALC HELD

Bit3 = Ns/Np too high

D3 indicates errors related to data entry.

Bit0 = Nearest Available

Bit1 = Units Mismatched

Bit2 = Connection Error

D4 indicates errors in insulation tests.

Bit0 = OVER RANGE

Bit1 = Current Too Large

Bit2 = Resistance Too Low

D5 represents some of the double-line pop-up messages

Bit0 = OVER TEMPERATURE, Bias Turned Off

Bit1 = SAFETY Bias Turned Off

D6 indicates errors related to DC Bias

Bit0 = Excess Voltage Drop

Bit1 = Bias Interlock

D7 is reserved.

Any of the above messages will set bit 2 of the Service Request Register. If "Range Error" or "Connection Error" occurs, pseudo - measurement results "999.9E+15, 999.9E+15" or "999.9E+15" will be produced dependent on the measurement function.

6.6.7 Common Commands

Common commands are listed below. Their detailed description will be given later.

Command	Name	Description
*CLS	Clear Status	This command clears the Event Status Register and associated status data structure.
*ESE <NR1>	Event Status Enable	This command sets the Event Status Enable Register to the value of the data following the command
*ESE?	Event Status Enable Query	Returns the current contents of the Standard Event Status Enable Register as an integer in the range 0 to 255.
*ESR?	Event Status Register Query	Returns the current contents of the Standard Event Status Register as an integer in the range 0 to 255. It also clears ESR.
*SRE <NR1>	Service Request Enable	Sets the Service Request Enable Register to the value following the command. The register is set except that bit 6 is ignored.
*SRE?	Service Request Enable Query	Returns the current contents of the Service Request Enable Register as an integer in the range 0 to 63 and 128 to 255
*STB?	Status Byte Query	Returns the current contents of the Status Byte with the Master Summary bits as an integer in the range 0 to 255. Bit 6 represents Master Summary Status rather than Request Service.
*IDN?	Identification Query	Returns the data identifying the 3260. (i.e. the data output will be: "WAYNE KERR,PMA3260A,0,1.0" where the first field is the manufacturer, then the model number, then a zero instead of a unique serial number, then the software revision number: here represented as Issue 1.0).
*RST	Reset	Resets the 3260 to a default setting. This command is equivalent to a power-up reset.
*TRG	Trigger	Trigger a direct measurement, but does not return the results to the controller. This is the same as a GET (Group Execute Trigger) command.
*OPT	Option Identification Query	Returns the hardware option installed in the 3260

6.6.8 Standard Operation Status Commands

Refer to section 6.6.6 for an explanation of the following commands.

Command	Description	Query
	Read Status Operation Condition register.	:STATus:OPERation:CONDition?
	Read Status Operation Event register	:STATus:OPERation:EVENT?
:STATus:OPERation:ENABle <NR1>	Set Status Operation Enable Register	

6.6.9 PMA3260A Device-Specific Commands

The subsystem commands are grouped in different modes similar to the local operation. The recommended discipline to control the instrument under GPIB is to select the mode and the type of test first, then change the measurement conditions. Changing the measurement conditions which are not in the present mode and type of test will be rejected and return error flag.

Note that some GPIB commands require discrete mnemonic parameters <disc>).

Impedance	Description	Query
:IMPedance	Select impedance mode.	
:IMP:TEST:RDC	Select Rdc measurement. Impedance test query returns 1 for RDC 0 for AC	:IMP:TEST?
:IMP:TEST:AC	Select AC measurement.	
:IMP:TRIGger	Trigger a Rdc or AC measurement and return results.	
:IMP:FREQuency <value>	Set frequency <value> if "AC meas" selected. <value> is decimal numeric data. Suffix multipliers K, M, G together with or without HZ are acceptable. Frequency query. if "AC meas" is selected, return measurement frequency in Hz as floating point number. e.g. 2.50E2 = 250Hz.	:IMP:FREQuency?
:IMP:LEVel <value>	Set AC level <value> if "AC meas" selected. <value> is decimal numeric data. Suffix A or V change the type of drive. If there is no suffix followed, it defaults to the previous type of drive. AC level query. if "AC meas" is selected, return measurement level in A or V as floating point number.	:IMP:LEVel?
:IMP:BIAS <value> or <disc>	Set DC bias <value> if "AC meas" selected. <value> is decimal numeric data. Suffix A is optional. <disc> - ON or OFF. Bias query. if "AC meas" is selected, return bias in A as floating point number. Bias status query. Returns bias status in integer. 0,1 are corresponding to OFF, ON respectively.	:IMP:BIAS? :IMP:BIAS-STATUS?
:IMP:SPEED <disc>	Select measurement speed <disc> - MAX, FAST, MED or SLOW. Speed query. Returns measurement speed in integer. 0,1,2,3 are corresponding to MAX, FAST, MED and SLOW respectively.	:IMP:SPEED?
:IMP:RANGE <disc>	Select auto-ranging or range-hold on range N. <disc> - AUTO, HOLD or integer 1 to 7. Range query. Returns measurement range in integer.	:IMP:RANGE?
:IMP:ALC <disc>	Select the state of Automatic Level Correction. <disc> - ON, OFF or HOLD. ALC status query. Returns ALC status in integer. 0,1,2 are corresponding to OFF, ON and HOLD respectively.	:IMP:ALC?
:IMP:EQU-CCT <disc>	Select equivalent circuit. <disc> - SER or PAR. Equivalent circuit query. Returns equivalent circuit status in integer. 0 and 1 are corresponding to PAR and SER respectively.	:IMP:EQU-CCT?
:IMP:FUNC:L :IMP:FUNC:C :IMP:FUNC:Z :IMP:FUNC:Q :IMP:FUNC:D :IMP:FUNC:R	Select major and minor terms. Major term query. Returns major term status in integer. 0,1,2 are corresponding to L, C, Z respectively. Minor term query. Returns minor term status in integer. 0,1,2 are corresponding to Q, D, R respectively.	:IMP:FUNC:MAJOR? :IMP:FUNC:MINOR?

Impedance	Description	Query
:IMP:SCALE <disc>	Select the state of scale bar. <disc> - ON or OFF. Scale status query. Returns scale status in integer. 0,1 are corresponding to OFF and ON respectively.	:IMP:SCALE?
:IMP:NOMinal <value>	Set nominal value. <value> is decimal numeric data. Suffix multipliers together with or without units are acceptable. The unit sent must match either the major or the minor terms. If there is no suffix followed, it defaults to the previous type of nominal. Nominal query. Returns nominal value in floating point number.	:IMP:NOMinal?
:IMP:LIMIT <disc>	Set percentage or absolute mode. <disc> - ABS or PERC. Limit query. Returns integer 0 or 1 corresponding to ABSolute or percentage mode.	:IMP:LIMIT?
:IMP:High-LIMIT <value>	Set percentage high limit. <value> is decimal numeric data. No suffix is allowed. High limit query. Returns high limit value as a floating point number.	:IMP:High-LIMIT?
:IMP:LOW-LIMIT <value>	Set percentage low limit. <value> is decimal numeric data. No suffix is allowed. Low limit query. Returns low limit value as a floating point number.	:IMP:LOW-LIMIT?

Transformer	Description	Query
:TRANSformer	Enter Transformer mode.	
:TRAN:TEST:Primary-LQ	Select Primary L+Q measurement. Tran test query returns integer: 0 P-LQ 1 Ratio 2 P-RDC 3 S-RDC 4 P-LE 5 S-LE 6 C	:TRAN:TEST?
:TRAN:TEST:RATIO	Select ratio measurement.	
:TRAN:TEST:Primary-RDC	Select Primary Rdc measurement.	
:TRAN:TEST:Secondary-RDC	Select Secondary Rdc measurement.	
:TRAN:TEST:Primary-LEakage	Select Primary Leakage measurement.	
:TRAN:TEST:Secondary-LEakage	Select Secondary Leakage measurement.	
:TRAN:TEST:Capacitance	Select interwinding capacitance measurement.	
:TRAN:TRIGger	Trigger a specified type of measurement and return results.	
:TRAN:FREQuency <value>	Set frequency <value> if an AC type of tests selected. <value> is decimal numeric data. Suffix multipliers K, M, G together with or without HZ are acceptable. Frequency query. if an AC type of test is selected, return measurement frequency in Hz as floating point number. e.g. 2.50E2 = 250Hz.	:TRAN:FREQuency?
:TRAN:LEVel <value>	Set AC level <value> if an AC type of tests selected. <value> is decimal numeric data. Suffix A or V change the type of drive. If there is no suffix followed, it defaults to the previous type of drive. Remember that current drive	:TRAN:LEVel?

Transformer	Description	Query
	is not available in Turns Ratio tests. AC level query. If an AC type of test is selected, return measurement level in A or V as floating point number.	
:TRAN:SPEED <disc>	Select measurement speed. <disc> - MAX, FAST, MED or SLOW. Speed query. Returns measurement speed in integer.0,1,2,3 corresponding to MAX, FAST, MED and SLOW respectively.	:TRAN:SPEED?
:TRAN:RANGE <disc>	Select auto-ranging or range-hold on range N. <disc> - AUTO, HOLD or integer 1 to 7. Range query. Returns measurement range as an integer.	:TRAN:RANGE?
:TRAN:ALC <disc>	Select the state of Automatic Level Correction. <disc> - ON, OFF or HOLD. ALC status query. Returns ALC status in integer. 0,1,2 are corresponding to OFF, ON and HOLD respectively.	:TRAN:ALC?
:TRAN:FUNC:NS/NP :TRAN:FUNC:NP/NS :TRAN:FUNC:NS <value>	Select the display of Turns Ratio measurement. <value> is decimal numeric data to specify the number of turns of Np. Major term query. Returns integer 0,1 or 2 to correspond to Ns/Np, Np/Ns or Ns respectively. Np query returns the value of Np as floating point number.	:TRAN:FUNC:MAJOR? :TRAN:FUNC:NP?
:TRAN:EQU-CCT <disc>	Select equivalent circuit. <disc> - SER, PAR and AUTO. Equivalent circuit query. Returns equivalent circuit status as an integer. 0, 1 and 2 are corresponding to Parallel, Series and AUTO respectively.	:TRAN:EQU-CCT?
:TRAN:RATio-CORRection <disc>	Select the type of transformer for turns ratio correction. <disc> is OFF, AUTO or NORM for Normal transformers (floating secondary) or Auto transformers (one end of secondary connected to Primary Low). Returns 0, 1, or 2 corresponding to OFF, NORM or AUTO.	:TRAN:RATio-CORRection?

Handler	Description	Query
:HANdler	Select handler mode.	
:HAN:TEST:RDC	Select Rdc measurement. Impedance test query returns 1 for RDC 0 for AC	:HAN:TEST?
:HAN:TEST:AC	Select AC measurement.	
:HAN:TEST:RATIO	Select Turns Ratio measurement.	
:HAN:FREQUency <value>	Set frequency <value> if "AC meas" selected. <value> is decimal numeric data. Suffix multipliers K, M, G together with or without HZ are acceptable. Frequency query. If "AC meas" is selected, return measurement frequency in Hz as floating point number. e.g. 2.50E2 = 250Hz.	:HAN:FREQUency?
:HAN:LEVel <value>	Set AC level <value> if "AC meas" selected. <value> is decimal numeric data. Suffix A or V change the type of drive. If there is no suffix followed, it defaults to the previous type of drive. AC level query. If "AC meas" is selected, return measurement level in A or V as floating point number.	:HAN:LEVel?
:HAN:BIAS <value> or <disc>	Set DC bias <value> if "AC meas" selected. <value> is decimal numeric data. Suffix A is optional. <disc> - ON or OFF. Bias query. If "AC meas" is selected, return bias in A as floating point number.	:HAN:BIAS? :HAN:BIAS-STATus?

Handler	Description	Query
	Bias status query. Returns bias status in integer. 0,1 are corresponding to OFF, ON respectively.	
:HAN:SPEED <disc>	Select measurement speed <disc> - MAX, FAST, MED or SLOW. Speed query. Returns measurement speed in integer. 0,1,2,3 are corresponding to MAX, FAST, MED and SLOW respectively.	:HAN:SPEED?
:HAN:RANGE <disc>	Select auto-ranging or range-hold on range N. <disc> - AUTO, HOLD or integer 1 to 7. Range query. Returns measurement range in integer.	:HAN:RANGE?
:HAN:ALC <disc>	Select the state of Automatic Level Correction. <disc> - ON, OFF or HOLD. ALC status query. Returns ALC status in integer. 0,1,2 are corresponding to OFF, ON and HOLD respectively.	:HAN:ALC?
:HAN:EQU-CCT <disc>	Select equivalent circuit. <disc> - SER or PAR. Equivalent circuit query. Returns equivalent circuit status in integer. 0 and 1 are corresponding to PAR and SER respectively.	:HAN:EQU-CCT?
:HAN:FUNC:L :HAN:FUNC:C :HAN:FUNC:Z :HAN:FUNC:Q :HAN:FUNC:D :HAN:FUNC:R	Select major and minor terms. Major term query. Returns major term status in integer. 0,1,2 are corresponding to L, C, Z respectively. Minor term query. Returns minor term status in integer. 0,1,2 are corresponding to Q, D, R respectively.	:HAN:FUNC:MAJOR? :HAN:FUNC:MINOR?
:HAN:FUNC:NS/NP :HAN:FUNC:NP/NS :HAN:FUNC:NS <value>	Select the display of Turns Ratio measurement. <value> is decimal numeric data to specify the number of turns of Np. Major term query. Returns integer 0,1 or 2 to correspond to Ns/Np, Np/NS or Ns respectively. Np query returns the value of Np as floating point number.	:HAN:FUNC:MAJOR? :HAN:FUNC:NP?
:HAN:CLRLCD	Clear the LCD Display	
:HAN:XCURSOR <value>	Set X cursor pixel position between 0 and 319	
:HAN:YCURSOR <value>	Set Y cursor pixel position between 0 and 239	
:HAN:DISP-SMALL <string>	Display string in small characters at current cursor position. Any alphanumeric character may be used within the string. Upper case characters only.	
:HAN:DISP-LARGE <string>	Display string in large characters at current cursor position. Any alphanumeric character may be used within the string. Upper case characters only.	
:HAN:RATIo-CORRection <disc>	Select the type of transformer for turns ratio correction. <disc> is OFF, AUTO or NORM for Normal transformers (floating secondary) or Auto transformers (one end of secondary connected to Primary Low). Returns 0, 1, or 2 corresponding to OFF, NORM or AUTO.	:HAN:RATIo-CORRection?

Insulation	Description	Query
:INSulation	Enter Insulation mode.	
:INS:PRImary-SECOndary	Select Primary to Secondary insulation measurement.	
:INS:PRImary-GND	Select Primary to ground insulation measurement.	
:INS:SECOndary-GND	Select Secondary to ground insulation measurement.	
:INS:LEVEl <int>	Set insulation test level <int>. <int> is decimal integer data. It can be either 100 200 or 500 only. Insulation test level query. return measurement level V as integer number 100, 200 or 500	:INS:LEVEl?

Insulation	Description	Query
:INS:DISPlay <disc>	Select display μ A or M Ω . <disc> - UA or MOHM.	
:INS:TRIGger	Trigger a specified type of measurement and return results.	

Binning	Description	Query
:BINning	Select one of the previously worked binning modes.	
:BIN:SET	Select BIN SET mode.	
:BIN:SORT	Select BIN SORT mode.	
:BIN:COUNT	Select BIN COUNT mode.	
:BIN:TEST <value>	Select one type of test in BIN SET mode. 1 - L + Q (Pri) 2 - L + R (Pri) 3 - C + D (Pri) 4 - Z + f (Pri) 5 - Ns/Np (Sec) 6 - Leakage L (Pri) 7 - Leakage L (Sec) 8 - Cs-p (Sec-Pri) 9 - L + R (Sec) 10 - Rdc (Pri) 11 - Rdc (Sec) 12 - Ins (Pri-Sec) 13 - Ins(Pri-GND) 14 - Ins(Sec-GND)	:BIN:TEST?
:BIN:NOMinal <value>	Set nominal <value> if Bin Set percentage mode is selected. <value> is decimal numeric data. Unit is not required. Nominal query. if Bin Set % is selected, return nominal value as floating point number. e.g. 0.325E-2.	:BIN:NOMinal?
:BIN:FREQuency <value>	Set frequency <value> if BIN SET selected. <value> is decimal numeric data. Suffix multipliers K, M, G together with or without HZ are acceptable. Frequency query. Return measurement frequency in Hz as floating point number. e.g. 2.50E2 = 250Hz.	:BIN:FREQuency?
:BIN:LEVel <value>	Set AC level <value> if BIN SET mode selected. <value> is decimal numeric data. Suffix A or V change the type of drive. If there is no suffix followed, it defaults to the previous type of drive. AC level query. Return measurement level in A or V as floating point number.	:BIN:LEVel?
:BIN:BIAS <value> or <disc>	Set DC bias <value> if BIN SET and AC tests on primary selected. <value> is decimal numeric data. Suffix A is optional. <disc> - ON or OFF. Bias query. Return bias in A as floating point number. Bias status query. Returns bias status in integer. 0,1 are corresponding to OFF, ON respectively.	:BIN:BIAS? :BIN:BIAS-STATUS?
:BIN:SPEED <disc>	Select measurement speed <disc> - MAX, FAST, MED or SLOW in BIN SET mode. Speed query. Returns measurement speed in integer. 0,1,2,3 are corresponding to MAX, FAST, MED and SLOW respectively.	:BIN:SPEED?
:BIN:RANGE <disc>	Select auto-ranging or range-hold on range N. <disc> - AUTO, HOLD or integer 1 to 7. Range query. Returns measurement range in integer.	:BIN:RANGE?
:BIN:ALC <disc>	Select the state of Automatic Level Correction. <disc> - ON, OFF or HOLD. ALC status query. Returns ALC status in integer. 0,1,2 are corresponding to OFF, ON and HOLD respectively.	:BIN:ALC?
:BIN:EQU-CCT <disc>	Select equivalent circuit. <disc> - SER or PAR. Equivalent circuit query. Returns equivalent circuit status in integer. 0 and 1 are corresponding to PAR and SER	:BIN:EQU-CCT?

Binning	Description	Query
	respectively.	
:BIN:LIMIT <disc>	Set percentage or absolute mode. <disc> - ABS or PERC. Limit query. Returns integer 0 or 1 corresponding to ABSolute or percentage mode.	:BIN:LIMIT?
:BIN:BIN <value>	In BIN SET, select a bin (bin 0 to bin 8) to manipulate. <value> is an integer 0 to 8. Bin number query. Return the present bin.	:BIN:BIN?
:BIN:High-LIMit <value>	Set high limit. <value> is decimal numeric data. No suffix is allowed. High limit query. Returns high limit value as a floating point number.	:BIN:High-LIMit?
:BIN:LOW-LIMit <value>	Set low limit. <value> is decimal numeric data. No suffix is allowed. Low limit query. Returns low limit value as a floating point number.	:BIN:LOW-LIMit?
:BIN:MINOR <value>	Set minor term limit if it is applicable on the selected test. <value> is decimal numeric data. No suffix is allowed. Minor term query. Returns low limit value as a floating point number.	:BIN:MINOR?
:BIN:TRIGger	In BIN SORT or BIN COUNT mode, trigger a measurement and return results. Note that only bin number is returned in BIN COUNT mode, measurement results and bin number are returned in BIN SORT mode. Delimiter is colon.	
:BIN:DEL-ALL	Reset all the bin counters in BIN COUNT mode.	
:BIN:DEL-LAST	Decrement by 1 in the most recent bin counter in BIN COUNT mode.	
:BIN:SAVE <value>	In BIN SET mode, save the present setup in the store <value>. <value> is an integer 1 to 99 inclusive.	
:BIN:RECALL <value>	In BIN SET mode, recall the setup in the store <value>. <value> is an integer 1 to 99 inclusive. If the setup is not found, an EXEcutable error is returned.	

Calibrate	Description	Query
:CALibrate	Enter Calibrate mode.	
:CAL:OC-TRIM-P <int>	Select primary open circuit trim. <int> specifies the frequency range. 1 - Spot trim. 2 - Up to 10kHz plus spot trim. 3 - Up to 100kHz plus spot trim. 4 - All frequencies plus spot trim. Calibrate result query returns integer 0 or 1 to represent FAIL or PASS.	:CAL:RESult?
:CAL:SC-TRIM-P <int>	Select primary short circuit trim. <int> specifies the frequency range. 1 - Spot trim. 2 - Up to 10kHz plus spot trim. 3 - Up to 100kHz plus spot trim. 4 - All frequencies plus spot trim. Calibrate result query returns integer 0 or 1 to represent FAIL or PASS.	:CAL:RESult?
:CAL:OC-TRIM-PS <int>	Select primary to secondary open circuit trim. <int> specifies the frequency range. 1 - Spot trim. 2 - Up to 10kHz plus spot trim. 3 - Up to 100kHz plus spot trim. 4 - All frequencies plus spot trim.	:CAL:RESult?

Calibrate	Description	Query
	Calibrate result query returns integer 0 or 1 to represent FAIL or PASS.	
:CAL:SC-TRIM-S <int>	Select secondary short circuit trim. <int> specifies the frequency range. 1 - Spot trim. 2 - Up to 10kHz plus spot trim. 3 - Up to 100kHz plus spot trim. 4 - All frequencies plus spot trim. Calibrate result query returns integer 0 or 1 to represent FAIL or PASS.	:CAL:RESult?
:CAL:SELF-CAL	Performs instrument self calibration. Disconnect front panel BNC connects before sending command. This command takes several minutes to complete.	:CAL:RESult?
:CAL:HAN:OC-TRIM <int>	Select open circuit trim. <int> for handler mode. Specifies the frequency range. 1 - Spot trim. 2 - Up to 10kHz plus spot trim. 3 - Up to 100kHz plus spot trim. 4 - All frequencies plus spot trim. Calibrate result query returns integer 0 or 1 to represent FAIL or PASS.	:CAL:HAN:RESult?
:CAL:HAN:INS-TRIM	Select open circuit trim for handler insulation test. It is effectively 2-terminal insulation trim.	:CAL:HAN:RESult?
:CAL:HAN:SC-TRIM <int>	Select short circuit trim. <int> for handler mode. Specifies the frequency range. 1 - Spot trim. 2 - Up to 10kHz plus spot trim. 3 - Up to 100kHz plus spot trim. 4 - All frequencies plus spot trim. Calibrate result query returns integer 0 or 1 to represent FAIL or PASS	:CAL:HAN:RESult?

Sequence	Description	Query
:SEquence	Enter Sequence Run mode.	
:SEQ:PROGram <int> <contents>	Download a sequence program from the controller. The program will be stored in the 3260 with the program number <int> 0 to 65535. If the program number exists, an Execute Error will be generated. Program query - Upload a sequence program to the controller. The program stored in the 3260 with the program number <int> 0 to 65535 is sent to the controller if it exists. If not, an Execute Error will be generated. <contents> conforms the IEEE 488.2 and SCPI "Definite Length Block Response Data".	:SEQ:PROGram? <int>
:SEQ:DELeTe <int>	Delete a sequence program. The program stored in the 3260 with the program number <int> 0 to 65535 will be deleted without warning if it exists. If not exist, an Execute Error will be generated.	
:SEQ:RUN <int>	Run a sequence program. The program stored in the 3260 with the program number <int> 0 to 65535 will be loaded and run if it exists. If not, an Execute Error will be generated. Sequence result query. Returns the result of the sequence executed in integer, 0 and 1 are corresponding to FAIL or PASS.	:SEQ:RESult?
	Returns the list of the sequence programs stored in the 3260. The program numbers are separated by commas.	:SEQ:LIST?
:SEQ:CLR	Clears all the sequence programs stored in the 3260. WARNING: This GPIB command will clear ALL the sequence data in the 3260, use with caution.	

Root commands	Description	Query
:TRIGger	Trigger a measurement if the present mode allowed and return the measurement results.	
	Return the encoded message number in hexadecimal format. Refer "Encoded Message Register" for details.	:MESSAge?
:LOC-TRIG <disc>	Select to enable local trigger or not. <disc> - ON, OFF. If it is enabled, press Trigger button on the front panel can make a measurement. Local trigger status query. Returns the status in integer. 0,1 are corresponding to OFF, ON respectively.	:LOC-TRIG?
:GLOBal <disc>	Select the global or non-global measurement conditions <disc> - ON, OFF GLOBal status query. Returns global status in integer. 0,1 are corresponding to OFF, ON respectively.	:GLOBal?
:TERMinal <int>	Select 2 or 4 terminal measurement. The valid <int> is 2 or 4 only. Terminal query returns the terminal status in integer 2 or 4.	:TERMinal?
:SETUP <disc>	Select set-up view ON or OFF. Some GPIB operations will be slightly faster when the set-up view is OFF. Set-up status query. Returns set-up status in integer. 0,1 are corresponding to OFF, ON respectively.	:SETUP?
:DISPlay <disc>	Select updating display ON or OFF. Triggering operations will be slightly faster when the results are not sent to the display. Updating display status query. Returns the status in integer. 0,1 are corresponding to OFF, ON respectively.	:DISPlay?
:FAST-GPIB <disc>	Select fast GPIB ON or OFF. Raw measurement results, without formatting, will be returned. The display will not	

Root commands	Description	Query
	be updated.	
:DUMP-SCReen	Dump screen bit-mapped information. The data conform to IEEE 488.2 or SCPI "Indefinite Length Arbitrary Block Response Data".	
	Mode query. Returns integer 1 - impedance mode 2 -Transformer mode 3 - Calibrate mode 4 - Insulation mode 6 or7 - Sequence mode 8 - Handler mode 9 - Status mode	:MODE?

Note: It is recommended to backup your sequence programs on your computer disks periodically. The space to store sequence programs in the instrument is very limited, so should only those frequently used programs be stored in the PMA3260A.

6.6.10 Programming Examples

An example to control impedance mode:

```
:IMP; :IMP:TEST:AC
:IMP:FREQ 1.2kHz; LEV 0.5V; BIAS 0.3; ALC ON; RANGE
AUTO
:IMP:SPEED FAST; EQU-CCT PAR
TRIG
```

An example to control transformer mode:

```
:TRAN; :TRAN:TEST:P-LQ
:TRAN:FREQ 1.5E3; LEV 0.5V; ALC ON; RANGE AUTO
:TRAN:SPEED SLOW; EQU-CCT AUTO
TRIG
```

An example to control insulation mode:

```
:INS; :INS:PRI-SEC
:INS:LEV 500; DISP MOHM
TRIG
```

Quick Basic Program to measure the impedance of a component at 1KHz.

```
' $INCLUDE: 'C:\GPIB-PC\QBDECL4.BAS' 'Location of
National Include file

'Written in QuickBasic V4.5

'PC with National Instruments GPIB card and drivers
installed.

'3260 at address 6 on GPIB bus
DIM buf$(200), mystr$(200)
DIM ValArray(20)          'Store values of trigger.
buf$ = SPACE$(200)
CALL IBFIND("DEV6", wk%)  '3260 is at address 6

'The following call is only necessary if used with the
NI488.2 drivers

'CALL IBCONFIG(WK%, 6, 1) 'Set to repeat addressing
'Check for error on IBFIND call.
IF wk% < 0 THEN
    PRINT Dev$; " not Found"
    END
END IF

'Set GPIB handshake timeout
CALL IBTMO(wk%, 14)      'Set to 30 second timeout
CLS
CALL IBWRT(wk%, "**SRE 128") 'Enable bit7 on SRQ.
'Enable calibrating bit on Status Enable Register
CALL IBWRT(wk%, ":STAT:OPER:ENAB 1")
' Goto CALIBRATE mode PMA3260A
CALL IBWRT(wk%, ":cal")
PRINT "O/C the measurement leads..."
DO
LOOP WHILE INKEY$ = ""    ' Press a key to continue.
' Perform open circuit trim
CALL IBWRT(wk%, ":cal:oc-trim-p 4")
' Wait until open circuit trim complete by
' monitoring calibrating bit on Status Condition
Register
DO
    CALL IBWRT(wk%, ":STAT:OPER:CON?")
```

```
)
)
)      CALL IBRD(wk%, buf$)
)
)      LOOP WHILE (VAL(buf$) AND 1) = 1
)
)      'Open circuit trim Pass or Fail
)      CALL IBWRT(wk%, ":cal:res?")
)      'Clear results buffer
)      buf$ = SPACE$(30)
)      'Get result
)      CALL IBRD(wk%, buf$): PRINT buf$
)      IF VAL(buf$) = 0 THEN PRINT "O/C Trim failed!"
)      PRINT "S/C the measurement leads..."
)      DO
)      LOOP WHILE INKEY$ = ""      ' Press a key to continue.
)      ' Perform open circuit trim
)      CALL IBWRT(wk%, ":cal:sc-trim-p 4")
)      DO
)      CALL IBWRT(wk%, ":STAT:OPER:CON?")
)      CALL IBRD(wk%, buf$)
)      LOOP WHILE (VAL(buf$) AND 1) = 1
)      CALL IBWRT(wk%, ":cal:res?")
)      buf$ = SPACE$(30)
)      CALL IBRD(wk%, buf$): PRINT buf$
)      IF VAL(buf$) = 0 THEN PRINT "S/C Trim failed!"
)      'Go to Impedance mode
)      CALL IBWRT(wk%, ":imp")
)      'Select AC measurement
)      CALL IBWRT(wk%, ":imp:test:ac")
)      'Set Frequency to 1khz and level 0.5Volt
)      CALL IBWRT(wk%, ":imp:freq 1000; lev 0.5")
)      'Trigger measurement and display on the PC screen
)      DO
)      CALL IBWRT(wk%, "TRIG")
)      buf$ = SPACE$(30)
)      'Read major and minor terms
)      CALL IBRD(wk%, buf$)
)      mystr$ = buf$
)      'Convert major term string to value
)
```

```

ValArray(1) = VAL(mystr$)
PRINT ValArray(1)
'Look for major and minor term delimiter
n = INSTR(mystr$, ", ")
'Extract minor term string
mystr$ = RIGHT$(buf$, LEN(mystr$) - (n + 1))
'Convert minor term string to value
ValArray(2) = VAL(mystr$)
PRINT ValArray(2)
LOOP WHILE INKEY$ = "" ' Press any key to terminate.
' Add code to process data stored in the ValArray
' The values are stored from ValArray(0).
END

```

Program to call the PC system Timer to provide a real time delay

```

DECLARE SUB delay (ti!)
'Delay program execution for 5 seconds
CALL delay(5)
END
SUB delay (ti)
    cu = TIMER
    DO: LOOP UNTIL (TIMER > cu + ti)
END SUB

```

6.7 Virtual Front Panel Software

6.7.1 Introduction

The Virtual Front Panel software enables a PMA3260P, with any option fitted, to be controlled using a PC and is intended to be used to verify the function of the instrument and PC GPIB interface. A GPIB Interface, manufactured by National Instruments, is required to be installed into a PC prior to installing this software.

The software, running under Microsoft 3.1x or Windows 95, provides a display resembling the PMA3260A front panel. The standard Windows GUI is used to simulate the 'soft' keys to the right of the PMA3260A LCD display while the menu options, controlled by the keypad, are converted into virtual push buttons or list boxes. The mouse and keyboard connected to the PC are used to operate all functions and enter data. All menu options available on the PMA3260A are available.

For production applications it may be necessary to develop application specific software in an appropriate language. Please see section 6.6 GPIB Control, for details of the GPIB commands available.

6.7.2 Hardware Requirements

IBM compatible PC with a 486 microprocessor or above with 4Mb RAM and 4Mb of hard disk space.

A National Instruments GPIB card installed in the PC with a GPIB cable connecting the PMA3260P to the PC.

Ensure the PMA3260P is set to the default address of six by checking the IEEE address switch on the rear panel.

6.7.3 Software Requirements

Windows 3.1x or Windows 95 with the appropriate software installed for the National Instruments GPIB card. The file gpib.dll should be in the \windows\system directory.

6.7.4 Installation

Run Windows 3.1x or Windows

Insert Disk 1 of the installation software into the floppy drive.

6.7.4.1 Windows 3.1x

Select from the file menu Run and type n:\setup where n is the floppy disk drive letter.

Follow the setup program instructions.

6.7.4.2 Windows 95

Select the start button

Select Run and type n:\setup where n is the floppy disk drive letter.

Follow the setup program instructions.

6.7.5 Using the Virtual Front Panel Software

Connect the PMA3260P to the PC via a GPIB interface cable.

During the installation process the setup install Virtual Front Panel Software icon into a dedicated folder. Select the icon and 'double click' using the left-hand mouse button to run the program.

The start up form will appear which will display the version number and release date; and communication with the PMA3260P will be established.

If an error message is displayed then the installation of the GPIB software should be checked together with the connection between the PC and the PMA3260P. Ensure also that the default GPIB address of six is selected using the rear panel switch.

Once communications have been achieved the current measurement conditions should be displayed in the Impedance Mode of the PMA3260P. Any errors will be reported.

6.7.5.1 Making the first Measurement

Click on the TRIGGER button to start a measurement and display results on the screen. Try changing measurement the speed of the measurement using the conditions such as sand trigger again. The measured values will be updated.

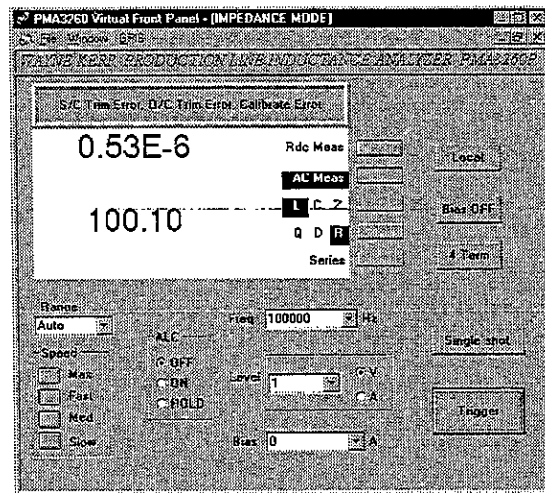

fig. 6.22 Impedance Mode

Errors will be reported included the requirement to trim or calibrate the Instrument.

6.7.5.2 Changing the Instrument Mode

The main Menu Window drop down list should be used to change to another instrument mode.

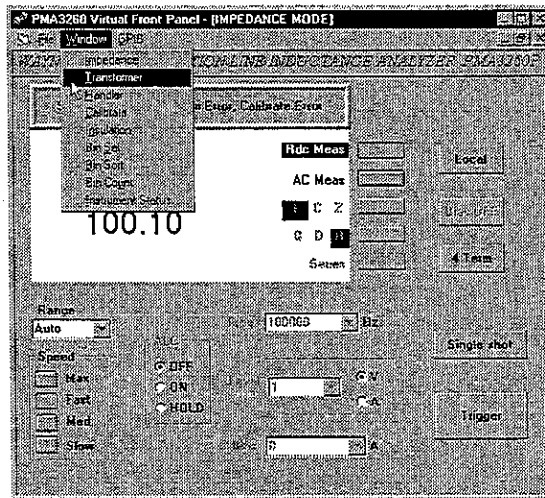

Fig. 6.23 Changing the Instrument Mode

All the main PMA3260P modes are available and may be used to perform measurements, calibrate or display the Instrument Status.

6.7.5.3 Instrument Status

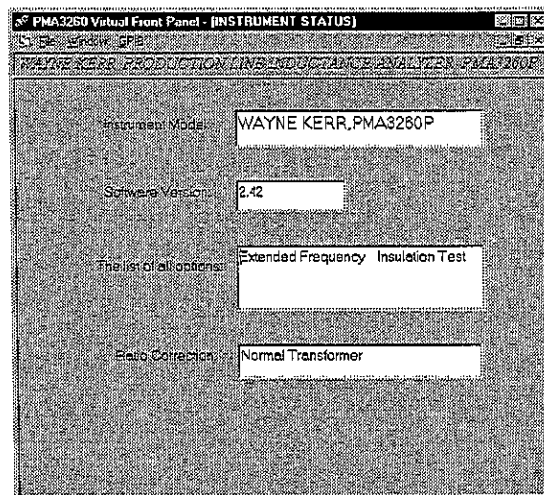

Fig.6.24 Instrument Status

The Instrument Status Mode shows the Instrument model, options fitted and the current setting of the ratio correction during Transformer Ratio Measurements.

6.7.5.4 Calibrating the Instrument

If calibration and trim errors are reported in the Error Message box it will be necessary to select the calibration mode by using Window from the main menu followed by Calibrate.

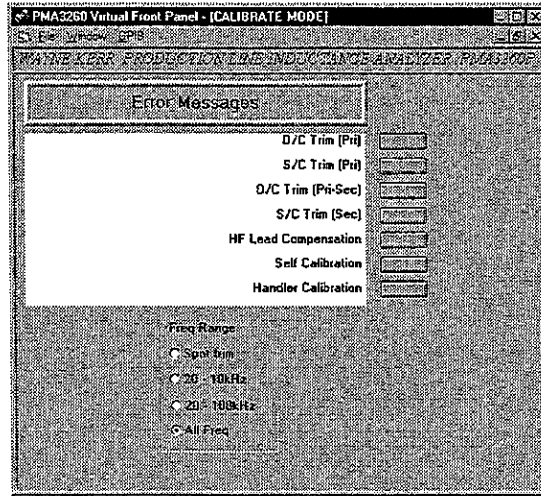

Fig. 6.25 Calibration Mode

From this menu all the Calibration and Trimming options may be selected using the Calibration Option 'Push Buttons' and the Frequency range options. Please refer to section 6.1.5 for more information on trimming, and section 6.2.17 for calibration.

6.7.5.5 Binning

Full control of the PMA3260P Binning Option is available using the BinSet, Bin Sort and Bin Count modes in the Main Window Menu. For an in depth understanding of the Binning facility in the PMA3260P please refer to section 6.3.3 Bin Handler Option.

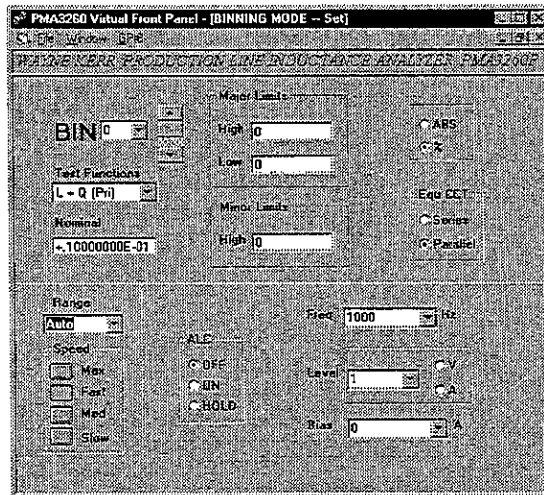

Fig. 6.26 Bin Set Mode

Use the Bin Set mode to set the test, with the required parameters, together with the Major, Minor and nominal limits. All parameters are stored in the PMA3260P. The Bin Sort and Bin Count modes allow data to be collected, showing measurement results, corresponding classification, type of test and measurement conditions.

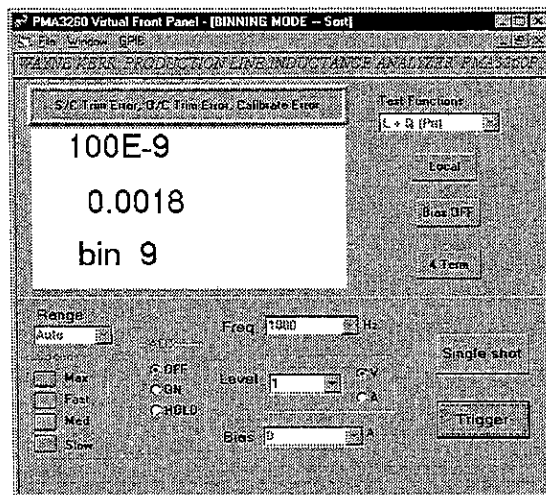

Fig. 6.27 Bin Sort Mode

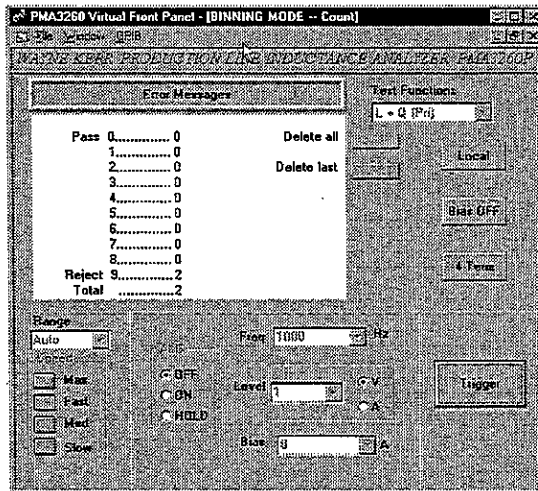

Fig. 6.28 Bin Count Mode

6.7.5.6 Data Logging

To start logging data a file must first be opened by selecting 'Open' from the File Main Menu. To start data being logged select Data Log On and results will be written to the file until Data Log Off is selected. Data logged to the file will overwrite any previous contents.

Data stored in the file is in text format using a tab delimiter consisting of Major and Minor terms, if applicable, in scientific format.

Each measurement is placed on a new line.

6.7.5.7 GPIB Control

The PMA3260P may be returned to Local control from the GPIB main menu by selecting 'Go To Local'.

The Local Trigger On option allows for the PMA3260P external trigger to be used.

6.8 Printer Operation

The printer output function is available on instruments fitted with software version 2.30 or above. For normal operation this provides a printout of test conditions and measurement results. For Sequence mode operation, test programs may be listed. During Sequence Run mode, a ticket print function is available. When enabled this prints out details of any test failures, together with statistical data at the end of each batch of testing.

Connections

A 25-way D type female connector on the rear panel conforms to the Centronics standard for parallel printers. A printer with a width of at least 40 characters is required.

The printer output must be enabled before use. Select MAIN MENU and key in code 30. If there is no printer connected or power is not on, the printer output will be disabled with a prompt message. When the 3260 is powered down or goes to remote control, the printer output is disabled automatically.

To disable the printer output select MAIN MENU and key in code 31.

6.8.1 Print Functions

Header

When the printer is enabled, the 3260 will print out a title together with the time and date in the following format:

```
Wayne Kerr PMA3260A
13:53:17 03 May 96
```

Status

The status of the selected measurement mode, such as :-

```
2-TERM IMPEDANCE MODE
```

will be output whenever the mode is selected or changed. CALIBRATE, SEQUENCE EDIT and INSTRUMENT STATUS are not measurement modes.

Test Conditions

A summary of the test conditions will be output whenever the type of test is changed, e.g. from Rdc to AC in IMPEDANCE mode.

```
AC Meas:
L Q Parallel
1.02Vac 1.0000kHz
DC Bias 0.00A OFF
Range Auto
Speed Fast
ALC off
```

If on selecting a mode the required test type is already selected press the highlighted key once to obtain this test condition summary.

Test Results

Test results are output to the printer whenever a single shot test is performed. The value of the frequency, test level or DC bias will be printed if highlighted in the test set up. For example printing out L and Q variation with frequency:-

```
400.00 Hz    13.90mH, 12.55
500.00 Hz    13.85mH, 13.12
600.00 Hz    13.79mH, 13.98
800.00 Hz    13.72mH, 14.52
1.0000kHz    13.61mH, 15.07
```

To obtain a print out of test results without the additional parameter move the test setup highlight to Range or Speed.

Sequence Program Listing

Prints programs stored in the 3260. It will only operate if the printer has been enabled by keying in code 30 from the main menu.

From Sequence Edit mode load a program and then key in code 34 to print out a listing in the following format :-

```
Program No: 1
Test Step 1  L + Q (Pri)
Freq: 1.0000kHz Level: 100.00mV
DC Bias: 0.0000 A      ALC: On
Range: Auto           Speed: Fast
Parallel
Major HI: 200.0mH     LO: 120mH
Minor HI: 50.00Q      LO: 30.00Q
Delay: 0.2s

Test Step 2  Rdc (Sec1)
Range: Auto      Speed: Max
Major HI: 40.00mohm LO: 25.00mohm
Delay: 1s

Test Step 3  Ns/Np (Sec1)
Freq: 10.000kHz Level: 1.000V
ALC: Off
Range: Auto           Speed: Fast
Major Hi: 505.0m      LO: 495.0m
```

Note that the multiplier μ is replaced by u and the unit Ω is replaced by ohm when printing out sequence programs.

Sequence Run mode

The ticket printer function will be activated whenever a test program is loaded and run with the printer enabled. The program number and start time will be output followed by details of any test failures. The action of running the program also initializes two counters which keep track of the total components and the number of failures in a batch. This statistical information will be output when the sequence program is terminated by pressing the Menu key. This key must first be unlocked (code 3260) if it is locked.

PROGRAM No.: 4
Start at 14:27:19 20 Jun 96

FAIL at Test Step 3 Leakage L (Pri)
Major Value: 11.23uH
High Limit: 10.00uH
Low Limit: 0.000 H

.....

Total components tested to
18:35:45 21 Jun 96: 1250
Number of failures: 78
Yield rate: 93.760%

Binning modes

From the Bin Set mode recall a setup and then key in code 34 to print out a listing in the following format. (Note that it will only operate if the printer has been enabled by keying in code 30 from the main menu.)

Bin	High H	Low H	Minor Q>x
0	+0.01	-0.01	10.000
1	+0.05	-0.05	10.000
2	+0.1	-0.1	5.0000
3	+0.5	-0.5	5.0000
4	+1.0	-1.0	0.0000
5	+2.0	-2.0	0.0000
6	0.0	0.0	0.0000
7	0.0	0.0	0.0000
8	0.0	0.0	0.0000

Nominal = 162.10mH

1.00 Vac 1.0000kHz
DC Bias: 0.00 A OFF
Equ cct: Parallel
Range Auto
Speed Fast
ALC off

In Bin Sort mode measurement results together with bin number are printed out.

162.20mH, 12.465 Q

Bin 2

161.00mH, 11.240 Q

Bin 4

In Bin Count mode a softkey PRINT, is provided when a printer is connected and printing is enabled. The example below indicates the data that is output :-

```

BINNING MODE - Count
Type of test: L + Q (Pri)
Bin  High H  Low H  Minor Q>x  Count
  0  +0.01  -0.01  10.000    0
  1  +0.05  -0.05  10.000    4
  2  +0.1   -0.1   5.0000    2
  3  +0.5   -0.5   5.0000   30
  4  +1.0   -1.0   0.0000   56
  5  +2.0   -2.0   0.0000   10
  6   0.0    0.0    0.0000    0
  7   0.0    0.0    0.0000    0
  8   0.0    0.0    0.0000    0
  9  Reject total                15
     Reject on major            12
                                Total  117

```

6.9 Back Panel

The back panel of the instrument is made up of three main areas; control connection to the left, input power to the right and a heatsink in the middle. See figure 6.29 below.

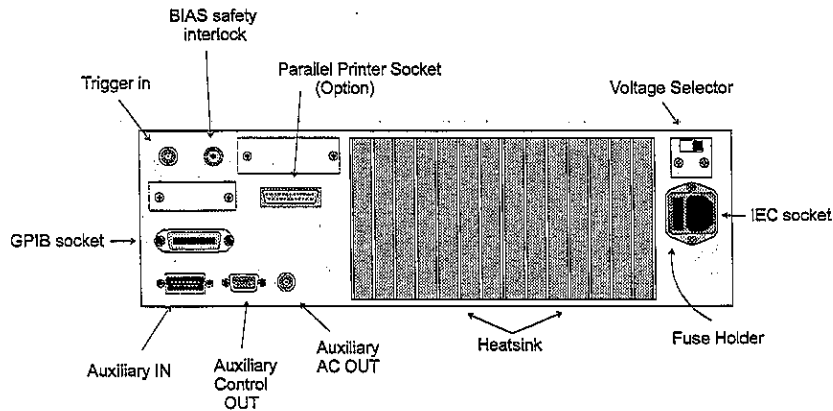

figure 6.29 PMA3260 Back Panel View

Control connections

There are seven control connection in all, these are outlined below with connector type and use.

	Type	Use	Reference
BIAS Safety interlock	3 pole 3.5mm Audio Jack Plug	To protect user against unintentional back emf's.	See section 6.9.1
GPIB socket	Standard GPIB	For remote operation.	See sections 6.9.2 and 6.6
Trigger IN	BNC	Duplicates action of front panel trigger key.	See section 6.9.3
Auxiliary IN	15 WAY 'D' type (male)	For future expansion	See section 6.9.4
Auxiliary Control OUT	9 WAY 'D' type (female)	For control of external options	See section 6.9.5
Auxiliary AC OUT	BNC	For future expansion	See section 6.9.6
Parallel Printer	25 WAY 'D' type (female)	To dump results to local printer	See sections 6.9.7 and 6.8
Bin Handler Interface Option	25 WAY 'D' type (male)	OPTION - to interface to Bin sorting equipment.	See sections 6.9.8 and 6.3.3
GPIB Address (PMA3260P Only)	Slide Switch	To set the GPIB to the default address or user specified.	See Sections 6.9.9 and 6.6.3

Table 6.1 Details of Rear panel control connections and switches

Power Connections

There is a standard IEC socket with a fuse holder combined. The fuse rating is different for the ac supply to be used,

230V AC 1A - 'T' type

110V AC 2A - 'T' type

Above the power socket, there is a voltage selector switch, this should be set as appropriate (230V AC or 110V AC).

6.9.1 SAFETY Interlock

For reasons of safety an interlock feature is incorporated into the analyzer. This prohibits any DC BIAS current until the safety interlock circuit is complete with the safety jack plug.

For maximum operator safety, particularly on production line testing, it is advisable to place the terminal fixture, for the inductor under test, within a housing with an interlocked door. The interlock jack socket is shown above in figure 6.29 with details in the table 6.1. The connections this provides are shown below in figure 6.30.

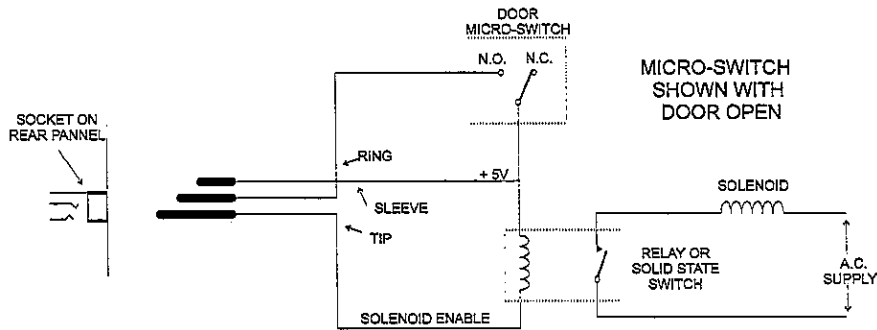

Figure 6.30 Typical BIAS interlock fixture

Only when the door is closed, and the microswitch therefore made, can the DC BIAS be activated. At this time, the relay is energized, activating an ac supply for a solenoid which can be used to lock to door while the BIAS remains available.

The solenoid drive relay should have a 5v dc coil of resistance not less than 200Ω. Diode coil protection is provided within the BIAS circuitry.

The door lock is activated when 'Bias On' is selected on the instrument. If the door switch or interlock lead is broken, the dc bias is inhibited.

IMPORTANT

If the Interlock feature is not required, it is necessary to insert the 3.5mm Audio jack, with the ring and sleeve connections linked, into the socket on the back panel. Failure to do this will result in the BIAS being inhibited, and the message, * Bias Interlock * being displayed.

6.9.2 GPIB

Devices should be connected to the PMA3260A using a standard GPIB 24 pin connector assembly utilizing shielded cable. Use of the standard connector consisting of a plug and receptacle is recommended and should be compatible with the Amphenol and Cinch Series 57 or Amp Champ.

GPIB Connector Pin Assignment

Pin	Description	Pin	Description
1	Data Line 1	13	Data Line 5
2	Data Line 2	14	Data Line 6
3	Data Line 3	15	Data Line 7
4	Data Line 4	16	Data Line 8
5	EOI (End or Identify)	17	REN (Remote Enable)
6	DAV (Data Valid)	18	Ground
7	NRFD (Not Ready For Data)	19	Ground
8	NDAC (Not Data Accepted)	20	Ground
9	IFC (Interface Clear)	21	Ground
10	SRQ (Service Request)	22	Ground
11	ATN (Attention)	23	Ground
12	Screen	24	Signal Ground

6.9.3 Trigger IN

The input is TTL compatible and when logic low is equivalent to operating the front panel 'Trigger' key. Note that this input is level sensitive and is fully 'debounced'. The input includes a pull up resistor which enables shorted contacts such as relays or footswitches to be used.

6.9.4 Auxiliary IN

For future expansion.

6.9.5 Auxiliary Control OUT

For future expansion.

6.9.6 Auxiliary AC OUT

For future expansion.

6.9.7 Parallel Printer

Parallel Printer Connector Pin Assignment

Pin	Description
1	Strobe
2	Data Line 0
3	Data Line 1
4	Data Line 2
5	Data Line 3
6	Data Line 4
7	Data Line 5
8	Data Line 6
9	Data Line 7
10	Acknowledge
11	Busy
12	Paper End
13	Select
14	Auto Feed
15	Error
16	Initialize Printer
17	Select Input
18	Ground (Data bit 0)
19	Ground (Data bit 1)
20	Ground (Data bit 2)
21	Ground (Data bit 3)
22	Ground (Data bit 4)
23	Ground (Data bit 5)
24	Ground (Data bit 6)
25	Ground (Data bit 7)

6.9.8 Bin Handler Interface

Bin Handler Interface pin assignment.

Pin	Description
1	Bin 0 select (active low)
2	Bin 1 select (active low)
3	Bin 2 select (active low)
4	Bin 3 select (active low)
13	Bin 4 select (active low)
14	Bin 5 select (active low)
15	Bin 6 select (active low)
16	Bin 7 select (active low)
17	Bin 8 select (active low)
18	Bin 9 select (active low)
19	Unused
20	Unused
21	Pass/Fail output
8	Trigger input
10	Busy output
5	BDA output
7	+5V Supply (<50mA)
24	Ground (0v)

Signal Levels

Output High >4V, Output Low <1V,

Input High >3.5V, Input Low <1.5V.

Drive capability typically is 10mA sink (low) and 30uA (high).

6.9.9 Set GPIB Address (PMA3260P Only)

The rear panel mounted slide switch is used to set the default GPIB address (6) or enables other user defined addresses to be used. Once another address is chosen, the switch should be moved from the default position.

7. CLEANING AND SAFETY INSPECTION

7.1 Cleaning

The outside of the equipment can be wiped with a cloth dampened with a mild detergent.

7.2 Safety Inspection

Periodically inspect the unit and associated wiring for damage e.g. dents or missing parts which might impair the safety or function of the equipment.

